

FLOOR
IS THE NEW
PLAYGROUND



LUXURY VINYL TILES



THE ULTIMATE
FLOORING EXPERIENCE

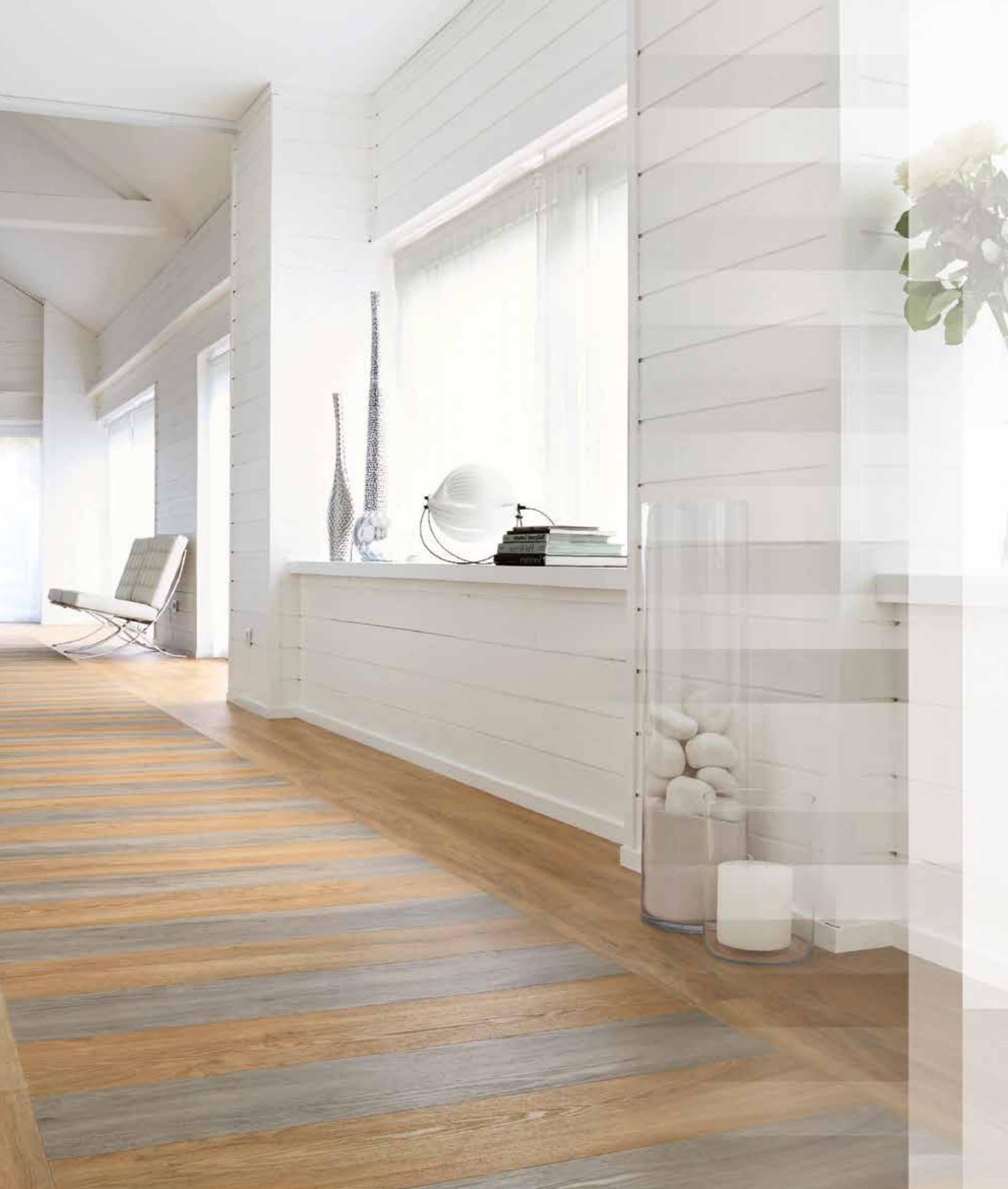

Tarkett Luxury Vinyl Tiles

Light, volume, colour and material – all play a part in shaping your interior design. The art lies in combining them, and Tarkett's LVT range makes a modular approach to flooring easy. Use the wide range of unique finishes to harmonise the look and feel, or ring the changes with creatively contrasting shades, textures and formats.

Express yourself with Tarkett LVT, because floor is the new playground.

SUMMARY

Glue-down:

iD Essential 30	04
iD Selection 40	20
iD Inspiration 55-70	34
iD Inspiration Limited Edition	60

Loose-lay:

iD Inspiration Loose-Lay	76
iD Square	92
iD Tilt	106

Click:

iD Essential Click	116
iD Inspiration Click	128

iD Essential 30

Explore our wide range of colours, surface aspects, formats and accessories to find the style you want. iD Essential 30 also features 12 colours with embossing in register where the surface is carved to match the natural essence of wood designs.





iD Essential 30

Go beyond convention and mix and match various finishes to create your fully personalised decor.



DOUBLE HERRINGBONE

2 colours - Buy 1/2 of each colour*

Uses models:

Washed Pine - Light Brown (24707 006)
Washed Pine - Snow (24707 007)

Plank format (cm): 22.9 x 121.9



WAVE REPEAT

2 colours - Buy 1/2 of each colour*

Uses models:

Washed Pine - Light Brown (24707 006)
Washed Pine - Snow (24707 007)

Plank format (cm): 22.9 x 121.9



MARBLE PATH

2 colours - Buy 1/2 of each colour*

Uses models:

Venezia - Beige (3979 002)
Original Slate - Black (3976 006)

Tile format (cm): 30.5 x 61



MIXED PATH

3 colours - Buy 1/3 of each colour*

Uses models:

Venezia - Beige (3979 002)
Original Slate - Grey (3979 007)
Original Slate - Black (3976 006)

Tile format (cm): 30.5 x 61

* Estimation based on this scaled square pattern



iD Essential 30

Go beyond convention and mix and match various finishes to create your fully personalised decor.

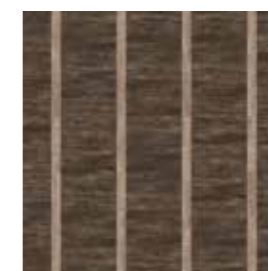

GARDEN ALLEY

2 colours - Buy 1/6 of Beige and 5/6 of Brown*

Uses models:
Country Oak - Beige (24707 001)
Country Oak - Brown (24707 000)

Plank format (cm): 22.9 x 121.9



JAPANESE GARDEN

2 colours - Buy 1/6 of Beige and 5/6 of Brown*

Uses models:
Venezia - Beige (3979 002)
Country Oak - Brown (24707 000)

Plank format (cm): 22.9 x 121.9
Tile format (cm): 30.5 x 61



HOUSE OF CARDS

2 colours - Buy 2/3 of Beige and 1/3 of Brown*

Uses models:
Venezia - Beige (3979 002)
Country Oak - Brown (24707 000)

Plank format (cm): 22.9 x 121.9
Tile format (cm): 30.5 x 61



ALICE IN WONDERLAND

2 colours - Buy 1/2 of each colour*

Uses models:
Venezia - Beige (3979 002)
Country Oak - Brown (24707 000)

Plank format (cm): 22.9 x 121.9
Tile format (cm): 30.5 x 61

* Estimation based on this scaled square pattern

LARGE PLANK WITH EMBOSSING IN REGISTER



CERUSED OAK* - BEIGE

24707 009
22.9 x 121.9 cm
LRV: 44.2%



CERUSED OAK* - LIGHT BROWN

24707 010
22.9 x 121.9 cm
LRV: 29.8%



CERUSED OAK* - BROWN

24707 011
22.9 x 121.9 cm
LRV: 24.4%



COUNTRY OAK - BEIGE

24707 001
22.9 x 121.9 cm
LRV: 23.6%



COUNTRY OAK - GREY

24707 003
22.9 x 121.9 cm
LRV: 22.1%



COUNTRY OAK - NATURAL

24707 002
22.9 x 121.9 cm
LRV: 13.3%



COUNTRY OAK - BROWN

24707 000
22.9 x 121.9 cm
LRV: 11.4%



WASHED PINE - WHITE

24707 004
22.9 x 121.9 cm
LRV: 40.2%



WASHED PINE - BEIGE

24707 005
22.9 x 121.9 cm
LRV: 44.4%



WASHED PINE - LIGHT BROWN

24707 006
22.9 x 121.9 cm
LRV: 32.8%



WASHED PINE - SNOW

24707 007
22.9 x 121.9 cm
LRV: 57.2%



WASHED PINE - BLUE

24707 008
22.9 x 121.9 cm
LRV: 26.7%

LARGE PLANK



SMOKED OAK - WHITE

3977 005
22.9 x 121.9 cm
LRV: 49.9%



SMOKED OAK - LIGHT GREY

3977 004
22.9 x 121.9 cm
LRV: 30.8%



SMOKED OAK - NATURAL

3977 002
22.9 x 121.9 cm
LRV: 18.0%



SMOKED OAK - BROWN

3977 001
22.9 x 121.9 cm
LRV: 10.1%



SMOKED OAK - DARK GREY

3977 003
22.9 x 121.9 cm
LRV: 15.0%



SMOKED OAK - BLACK

3977 000
22.9 x 121.9 cm
LRV: 4.3%



PRIMARY PINE - WHITE

3977 021
22.9 x 121.9 cm
LRV: 57.6%



PRIMARY PINE - NATURAL

3977 020
22.9 x 121.9 cm
LRV: 21.9%



PRIMARY PINE - GREGE

3977 018
22.9 x 121.9 cm
LRV: 30.1%



PRIMARY PINE - DARK GREY

3977 019
22.9 x 121.9 cm
LRV: 20.3%



PRIMARY PINE - DARK BROWN

3977 017
22.9 x 121.9 cm
LRV: 11.9%



SOFT OAK - WHITE

3977 011
22.9 x 121.9 cm
LRV: 53.0%

*Cerused oak decors offer a large variety of patterns so colours may vary from one plank to the other within the same box.

LARGE PLANK



SOFT OAK - LIGHT BEIGE

3977 015
22.9 x 121.9 cm
LRV: 40.6%



SOFT OAK - BEIGE

3977 009 22.9 x 121.9 cm
3976 009 15.2 x 91.4 cm
LRV: 31.4%



SOFT OAK - LIGHT BROWN

3977 012 22.9 x 121.9 cm
3976 012 15.2 x 91.4 cm
LRV: 30.5%



SOFT OAK - LIGHT GREY

3977 010 22.9 x 121.9 cm
3976 010 15.2 x 91.4 cm
LRV: 23.7%



SOFT OAK - NATURAL

3977 008 22.9 x 121.9 cm
3976 008 15.2 x 91.4 cm
LRV: 22.3%



SOFT OAK - BROWN

3977 007
22.9 x 121.9 cm
LRV: 14.6%



ASPEN OAK - GREY

3977 013
22.9 x 121.9 cm
LRV: 22.6%



ASPEN OAK - NATURAL

3977 016
22.9 x 121.9 cm
LRV: 20.8%

STANDARD PLANK



ASPEN OAK - BEIGE

3977 014
22.9 x 121.9 cm
LRV: 43.7%



WALNUT - LIGHT BROWN

3976 034
15.2 x 91.4 cm
LRV: 5.7%



BEECH - NATURAL

3976 020
15.2 x 91.4 cm
LRV: 29.8%



MAPLE - NATURAL

3976 031
15.2 x 91.4 cm
LRV: 43.1%

TILE



VENEZIA - BEIGE

3979 002
61 x 30.5 cm
LRV: 41.9%



VENEZIA - GREY

3979 001
61 x 30.5 cm
LRV: 21.3%



SCRATCHED METAL - GREY

3979 008
61 x 30.5 cm
LRV: 20.6%



ORIGINAL SLATE - GREY

3979 007
61 x 30.5 cm
LRV: 35.0%



ORIGINAL SLATE - BLACK

3979 006
61 x 30.5 cm
LRV: 4.2%



SANDSTONE - BROWN

3979 005
61 x 30.5 cm
LRV: 15.6%



SANDSTONE - BLACK

3979 004
61 x 30.5 cm
LRV: 6.6%

iD Essential 30

There are 3 patterns and 12 different colours available with embossing in register in the iD Essential 30 collection. This technique is used to create a precise texture that enhances a wood design. The surface is carved to match the natural essence of the wood, but unlike real wood, the surface interior does not absorb water and dirt and can be easily cleaned.

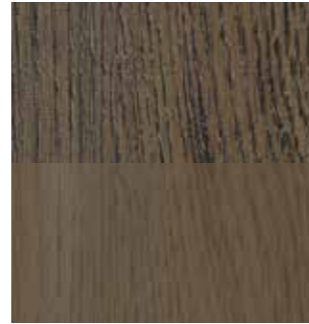

Zoom of the plank once engraved

Original pattern printed on the film

GREAT DESIGN OPTIONS

- 50 colour options and 9 different surface aspects
- Plank and tile dimensions that you can combine to compose your own flooring expressions

GREAT RESISTANCE AND EASY CLEANING

- Treated with the Tarkett TopClean™ surface protection that hardens the surface and simplifies cleaning and maintenance through reduced use of water, energy and chemical detergents.

A PEOPLE-FRIENDLY SOLUTION

- Tarkett aims to provide tangible environmental and health benefits to flooring users, for domestic and light commercial use.
- Includes 2 eco-innovations that contribute environmental and indoor air quality benefits.



- Total VOC emissions are at least 10 times lower than Europe's strictest standards.



- Uses a phthalate-free technology, based on alternative plasticizers that can be used for sensitive applications such as the production of toys, food packaging and medical devices.

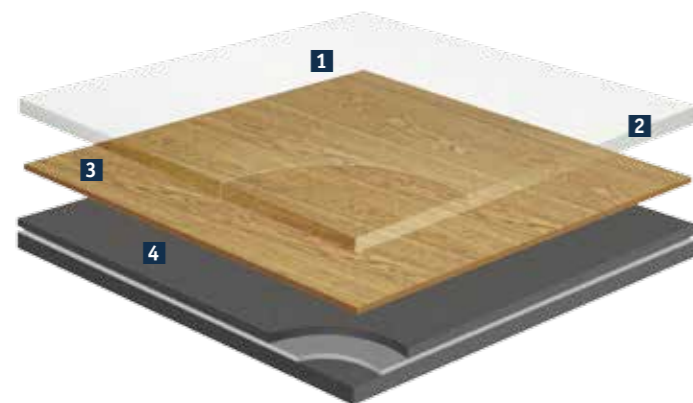

1. TopClean™ surface treatment
easy maintenance and higher resistance

2. Ultra tough transparent PVC wear layer

3. Design
printed PVC film

4. PVC Compact
backing and middle layers



Skirting



1 PVC DECORATIVE SKIRTING

Compact skirting with decorative film and PUR surface treatment. Perfect matching with 22 iD Essential 30 references, see column 1 in the skirting chart below (10 x 60 x 2020 mm).
Ordering unit: 16 units of 2.02 lm.

2 LARGE DECORATIVE SKIRTING

8025 ---
Large laminate skirting (17 x 60 x 2400 mm, 21 LVT resembling colours available).
Ordering unit: 10 units of 2.4 lm.
Fixing system available: plastic clip holders.

Design & Colours	1	2
SMOKED OAK-BLACK	-	8025 239
SMOKED OAK-BROWN	24640 212	8025 197
SMOKED OAK-NATURAL	-	8025 327
SMOKED OAK-DARK GREY	24640 211	8025 303
SMOKED OAK-LIGHT GREY	24640 210	8025 129
SMOKED OAK-WHITE	-	8025 326
SOFT OAK-BROWN	24640 218	8025 214
SOFT OAK-NATURAL	24640 215	8025 006
SOFT OAK-BEIGE	24640 217	8025 217
SOFT OAK-LIGHT GREY	24640 219	8025 214
SOFT OAK-WHITE	-	8025 240
SOFT OAK-LIGHT BROWN	24640 218	8025 006
SOFT OAK-LIGHT BEIGE	24640 216	-
ASPEN OAK-GREY	-	8025 326
ASPEN OAK-BEIGE	-	8025 326

Design & Colours	1	2
COLOURED PINE-GREY	26640 201	-
BEECH-NATURAL	-	8025 006
COUNTRY OAK-BEIGE	24640 238	-
COUNTRY OAK-NATURAL	24640 237	-
COUNTRY OAK-GREY	24640 236	-
WASHED PINE-WHITE	24640 206	-
WASHED PINE-BEIGE	24640 204	-
WASHED PINE-LIGHT BROWN	24640 205	-
WASHED PINE-SNOW	24640 202	-
WASHED PINE-BLUE	24640 203	-
CERUSED OAK-BEIGE	24640 207	8025 326
CERUSED OAK-LIGHT BROWN	24640 209	8025 326
CERUSED OAK-BROWN	24640 208	8025 326
VENEZIA-GREY	24640 224	8025 284
SANDSTONE-BLACK	-	8025 283

Underlay

TARKOFLAT LOOSE-LAY

Ready-to-use solution

- Reduces slight unevenness in older subfloors by up to 1.5mm depth and 3mm width
- Prevents telegraphic effect, the appearance of bumps and ridges from the substrate by up to 1.5mm depth
- Residential and light traffic commercial applications (Class 32 max.)

Quick and easy to install*

Ref.: 3568 004 - Grey



Profile

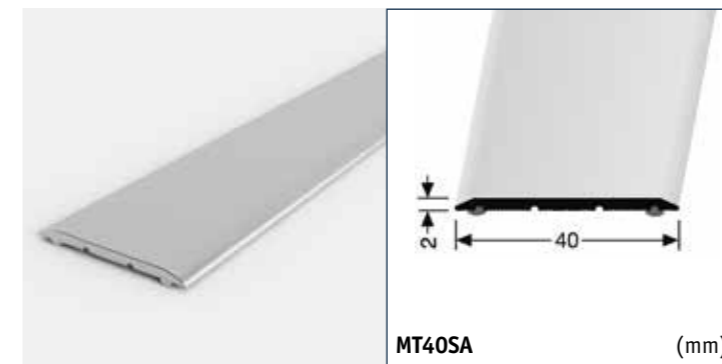

SELF-ADHESIVE TRANSITION PROFILE

Self-adhesive aluminium transition strip, for a perfect transition between different flooring materials. Suitable for use in heavy traffic areas.

1 colour: Ref.: Silver 1470 008
Delivery form: 10 units of 2.7 lm

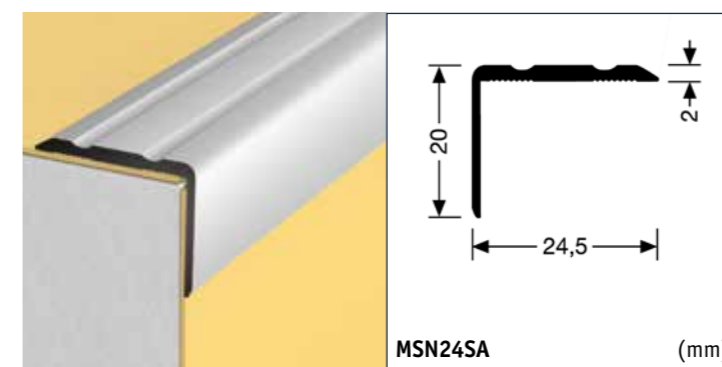

TRANSITION PROFILE

Aluminium transition profile, to be screwed.

1 colour: Ref.: Silver 1480 008
Delivery form: 10 units of 2.7 lm

*Tarkett recommend a selection of manufacturer adhesive (list available at: professionals.tarkett.com/content/list-recommended-adhesives). It is the responsibility of the adhesive manufacturer and flooring contractor to ensure the product being used is appropriate to use and applied in accordance with the manufacturer recommendations.



Specification

Luxury vinyl floorcovering in tiles and planks for domestic and light commercial use.
 TopClean™ polyurethane reinforcement. Product standard: ISO 10582.

CERTIFICATION & CLASSIFICATION	STANDARDS	iD Essential 30
Type of floor covering	ISO 10582	Compact Resilient Floorcovering
CE certification	EN 14041	Yes
Classification	EN ISO 10874 (EN 685)	Domestic: 23 Commercial: 31
TECHNICAL CHARACTERISTICS	STANDARDS	iD Essential 30
Total thickness	EN ISO 24346 (EN 428)	2.0 mm
Wear layer thickness	EN ISO 24340 (EN 429)	0.30 mm
Surface treatment (PUR)		TopClean™
Total weight	EN ISO 23997 (EN 430)	3.400 g/m ²
Wear layer binder content	ISO 10582	Type I
Form of delivery	EN ISO 24342 (EN 427) Planks Box	15.2 x 91.4 cm - 24 planks /box = 3.34 m ² art. no. 3976 ___ 3 digit colour number 22.9 x 121.9 cm art. no. 3977 / 24707 ___ 3 digit colour number Tiles 30.5 x 61.0 cm - 18 tiles/box = 3.34 m ² art. no. 3979 ___ 3 digit colour number
TECHNICAL PERFORMANCES	STANDARDS	iD Essential 30
Dimensional stability	EN ISO 23999 (EN 434)	≤ 0.25 %
Reaction to fire	EN 13501-1	B _n -s1 glued over A2fl or A1fl substrate (concrete)
Residual indentation	EN ISO 24343-1 (EN 433)	Required value: ≤ 0.10 mm Average measured value: 0.03 mm
Furniture leg	EN 424	No damage
Castor chair	ISO 4918 (EN 425)	No damage
Curl resultant to heat	EN ISO 23999 (EN 434)	≤ 2 mm
Thermal resistance	EN ISO 10456	0.07 m ² K/W
Underfloor heating		Suitable – max. 27°C
Impact sound reduction	EN ISO 140-8 EN ISO 717/2	ΔL _w = 4 dB
Light fastness	EN ISO 105-B02	≥ 6
Resistance to chemicals	EN ISO 26987 (EN 423)	Good resistance
Slip resistance	DIN 51130 EN 13893	R9
Electrical properties	EN 1815 EN 1081	< 2 kV on concrete R _t > 10 ¹⁰ Ω
Colours		Wood: 36 - Ceramic: 7

Technical data in force upon the date of publication (11/15). The values correspond to laboratory tests (no in situ test) and are subject to modification. Tarkett's instructions regarding installation, cleaning and maintenance shall be observed. Please contact your local sales rep. for these instructions.

CUSTOMS TARIFF: 48205000000F

Our Sustainability tag explains the content of our products and how they contribute to our sustainability strategy and human well-being.

TARKETT SUSTAINABILITY TAG

100% Recyclable

PHTHALATE FREE Technology
* EXCEPT RECYCLED CONTENT

< 100 µg/m³
Better Indoor Air Quality
* TVOC AT 28 DAYS

U
@euronorm

ÉMISSIONS DANS L'AIR INTÉRIEUR
A+
A+ A B C

GARANTEE 10 ans

CE
EN 14041:2004

iD Essential 30
0120-043-DOP-2013-04
http://professionals.tarkett.com
Distributed by: Tarkett France
2 avenue François Sommer,
F-08203 Sedan Cedex

According to European Classification EN 685
31 23

Top Clean
PUR REINFORCED

NO WAX
NO POLISH

iD Selection 40

Choose from a wide range of colours, formats and accessories in a hardwearing and resistant flooring for semi-commercial use. iD Selection 40 has 30 on-trend designs inspired by authentic materials – light to darker woods & stone to metallic decors.





iD Selection 40

Give yourself the creativity and versatility to personalise your interior decor.

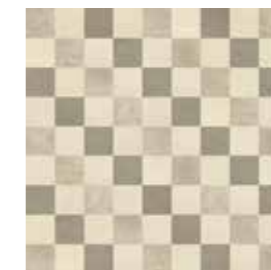

BISHOP MOVES

3 colours - Buy 1/3 of each colour*

Uses models:

Concrete - Dark Grege (226)

Concrete - Grey (225)

Rock - Natural Grey (228)

Tile format (cm): 50 x 50



CUBE

3 colours - Buy 4/9 of Dark Grege (226), 1/9 of Grey (225) and 4/9 of Natural Grey (228)*

Uses models:

Concrete - Dark Grege (226)

Concrete - Grey (225)

Rock - Natural Grey (228)

Tile format (cm): 50 x 50



SQUARED PALETTE

3 colours - Buy 1/3 of each colour*

Uses models:

Soft Walnut - Classical (202)

Concrete - Dark Grege (226)

Concrete - Grey (225)

Plank format (cm): 16.66 x 100

Tile format (cm): 50 x 50

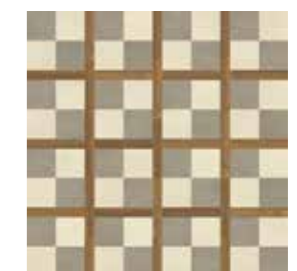

SQUARED CHESS

3 colours - Buy 1/3 of each colour*

Uses models:

Soft Walnut - Classical (202)

Concrete - Dark Grege (226)

Concrete - Grey (225)

Plank format (cm): 16.66 x 100

Tile format (cm): 50 x 50

* Estimation based on this scaled square pattern



iD Selection 40

Give yourself the creativity and versatility to personalise your interior decor.



RAILWAY TRACK

4 colours - Buy 1/4 of each colour*

Uses models:

Antik Oak - Light Brown (208)
Rust Metal - Grey (223)
Rust Metal - Bronze (222)
Vintage Zinc - Alu (229)

Plank format (cm): 25 x 122
Tile format (cm): 30.5 x 61



LINEAR TOWER

3 colours - Buy 1/3 of each colour*

Uses models:

Antik Oak - Light Brown (208)
Rust Metal - Grey (223)
Rust Metal - Bronze (222)

Plank format (cm): 25 x 122
Tile format (cm): 30.5 x 61



RYTHMICAL PULSE

3 colours - Buy 1/6 of Light Brown,
1/6 of White and 4/6 of Bronze*

Uses models:

Antik Oak - Light Brown (208)
Antik Oak - White (209)
Rust Metal - Bronze (222)

Plank format (cm): 25 x 122
Tile format (cm): 30.5 x 61



ACCORDION

3 colours - Buy 1/6 of Light Brown,
1/6 of White and 4/6 of Grey*

Uses models:

Antik Oak - Light Brown (208)
Antik Oak - White (209)
Rust Metal - Grey (223)

Plank format (cm): 25 x 122
Tile format (cm): 30.5 x 61

* Estimation based on this scaled square pattern

PLANK



MODERN OAK - BEIGE

4641 214
20 x 122 cm



MODERN OAK - CLASSICAL

4641 215
20 x 122 cm



MODERN OAK - LIGHT BROWN

4641 216
20 x 122 cm



MODERN OAK - WHITE

4641 213
20 x 122 cm



ANTIK OAK - GREGE

4642 210
25 x 122 cm



BRUSHED PINE - WHITE

4642 016
25 x 122 cm



BRUSHED PINE - NATURAL GREY

4642 221
25 x 122 cm



BRUSHED PINE - LIGHT BROWN

4642 220
25 x 122 cm



ENGLISH OAK - GREGE

4641 206
20 x 122 cm



ENGLISH OAK - CLASSICAL

4641 205
20 x 122 cm



ENGLISH OAK - DARK BROWN

4641 207
20 x 122 cm



NATURAL WALNUT - DARK BROWN

4641 203
20 x 122 cm



CONCRETE WOOD - WHITE

4642 217
25 x 122 cm



CONCRETE WOOD - BROWN

4642 218
25 x 122 cm



SOFT WALNUT - CLASSICAL

4640 202
16.66 x 100 cm



SOFT WALNUT - RED BROWN

4640 201
16.66 x 100 cm



ANTIK OAK - WHITE

4642 209
25 x 122 cm



ANTIK OAK - CLASSICAL

4642 211
25 x 122 cm



ANTIK OAK - LIGHT BROWN

4642 208
25 x 122 cm



ANTIK OAK - DARK BROWN

4642 212
25 x 122 cm



MAPLE - STUDIO

4640 204
16.66 x 100 cm



BEECH - MEDIUM

4640 200
16.66 x 100 cm

iD Selection 40

TILE



VINTAGE ZINC - ALU

4644 229
30.5 x 61 cm



RUST METAL - GREY

4644 223
30.5 x 61 cm



RUST METAL - BRONZE

4644 222
30.5 x 61 cm



CONCRETE - GREY

4643 225
50 X 50 cm



CONCRETE - DARK GREGE

4643 226
50 X 50 cm



RUSTIC SLATE - CHARCOAL

4645 224
61 X 61 cm



ROCK - GREY

4643 227
50 X 50 cm



ROCK - NATURAL GREY

4643 228
50 X 50 cm



iD Selection 40

iD Selection 40 offers a high quality and comfortable flooring for everyone's daily experience. Its design flexibility and durability makes it a great choice for commercial interiors with light traffic from hotels, offices, stores and shops to aged care facilities.

CREATE YOUR OWN DECORATIVE LAYOUT

- Gives you the versatility to create unique interiors with a carefully chosen range of 30 colours and patterns, surface structures and variety of plank and tile formats.

GREAT RESISTANCE AND EASY CLEANING

- Treated with TopClean XP™ surface protection that hardens the surface and simplifies cleaning and maintenance through reduced use of water, energy and chemical detergents.

DESIGNED IN EUROPE AND MADE IN GERMANY

- Created by our design team in Europe to the latest trends explored in the Tarkett Observer design study.
- Made in Germany to benefit from our best-in-class industrial expertise. It guarantees a high quality, long-lasting flooring supported by a reactive distribution and excellent customer service.

A SUSTAINABLE SOLUTION

- 100% recyclable.
- Contributes to improved indoor air quality with VOC emissions below quantifiable level, less than 10ug/m³ after 28 days.
- Uses a phthalate-free technology, based on alternative plasticizers that can be used for sensitive applications such as the production of toys, food packaging and medical devices.

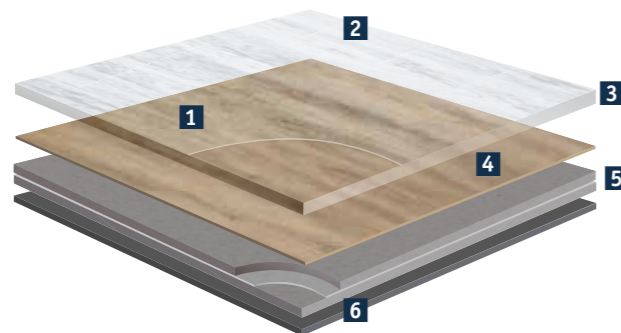

- 1. Surface embossing:** textures close to real materials
- 2. TopClean XP™ PUR reinforcement:** extreme resistance and easy low cost maintenance
- 3. 0.40mm pure PVC transparent wear layer:** exceptionally hardwearing and indentation resistant
- 4. 30 design options in high definition printing:** realistic designs
- 5. Unique composite structure built with solid homogeneous calandered layers reinforced with non-woven glass fibre:** exceptional dimensional stability and excellent resistance to tear and indentation
- 6. PVC backing**

Accessories

Skirting



RIGID DECORATIVE SKIRTING WITH MATERIAL TO BE INSERTED

1448 ---
IS 60
(For straight walls, 10 x 60 x 2570 mm, 3 colours available).
Ordering unit: 20 units of 2.5 lm.
1462 ---
ISS 60
(for straight walls, 20 x 120 x 2570 mm, 6 colours available).
Ordering unit: 20 units of 2.5 lm.
Also available in flexible decorative skirtings (7 x 60 x 2500 mm).



LARGE DECORATIVE SKIRTING

8025 ---
Large laminate skirting (17 x 60 x 2400 mm, 21 LVT resembling colours available).
Ordering unit: 10 units of 2.4 lm.
Fixing system available: plastic clip holders.

Feature strip

Create visual effects with contrasts of colours to highlight interior features, shape perceptions of room size or personalise your flooring design in plank or tile arrangements. iD Selection 40 comes with 9 coloured feature lines for more creative design possibilities.

BLACK	1421 001
SILVER	1421 002
COPPER	1421 003
PHOSPHORESCENT	1421 005
GREEN	1421 006
TAUPE	1421 007
TOBACCO	1421 008
DARK GREY	1421 009
RED	1421 010

Tarkoflat Loose-lay

Ready-to-use solution

- Reduces slight unevenness in older subfloors by up to 1.5mm depth and 3mm width
- Prevents telegraphic effect, the appearance of bumps and ridges from the substrate by up to 1.5mm depth
- Residential and light traffic commercial applications (Class 32 max.)

Quick and easy to install*

Ref.: 3568 004 - Grey



*Tarkett recommend a selection of manufacturer adhesive (list available at: professionals.tarkett.com/content/list-recommended-adhesives). It is the responsibility of the adhesive manufacturer and flooring contractor to ensure the product being used is appropriate to use and applied in accordance with the manufacturer recommendations.

iD Selection 40

Profile

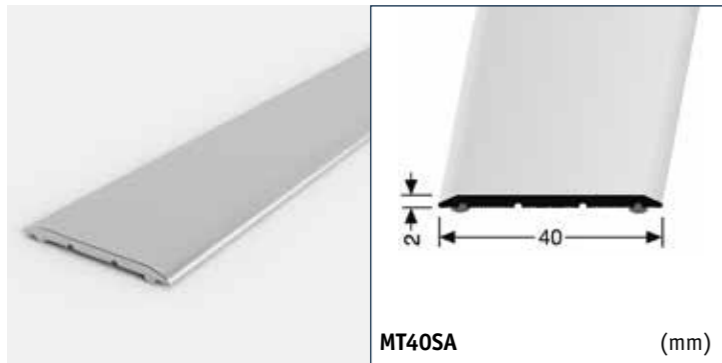

SELF-ADHESIVE TRANSITION PROFILE

Self-adhesive aluminium transition strip, for a perfect transition between different flooring materials. Suitable for use in heavy traffic areas.

1 colour: Ref.: Silver 1470 008
Delivery form: 10 units of 2.7 lm

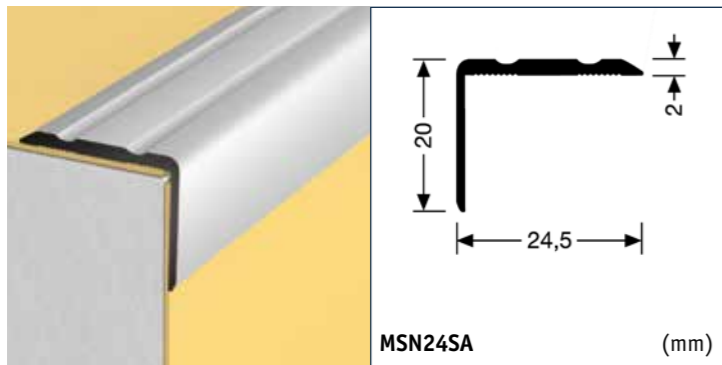

TRANSITION PROFILE

Aluminium transition profile, to be screwed.

1 colour: Ref.: Silver 1480 008
Delivery form: 10 units of 2.7 lm

Accessibility



WARNING TILE

Helps recognize a change in level, in accordance with regulatory requirements for disabled access and safety. Various formats available. Self-adhesive or to be glued to the floorcovering (according to product).

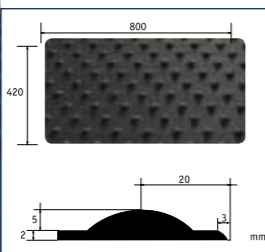

Self-adhesive rectangular tiles
Format: 815 x 420 x 8mm
Ordering unit: 1 box of 6 tiles

Self-adhesive square tiles
Format: 450 x 420 x 8mm
Ordering unit: 1 box of 20 tiles

Self-adhesive

	Rectangular tile	Square tile
White	1440 350	1440 450
Grey	1440 351	1440 451
Black	1440 352	1440 452
Ivory	1440 353	1440 453
Red	1440 354	1440 454
Yellow	1440 355	1440 455

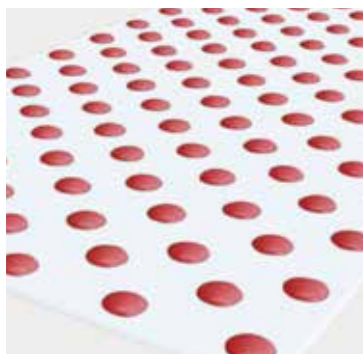

3D STUD

Ready-to-use podotactile studs to be simply fitted on top of the existing floorcovering.

Format (stud): 5 x 25mm
Ordering unit: 1 box of 200 studs

Self-adhesive

White	1440 050
Grey	1440 051
Black	1440 052
Ivory	1440 053
Red	1440 054
Yellow	1440 055

Specification

Modular vinyl floorcovering, with glass fibre reinforcement. TopClean XP™ polyurethane reinforcement. In plank and tile form. Product standard: ISO 10582.

CERTIFICATION & CLASSIFICATION	STANDARDS	iD Selection 40
Type of floor covering	EN ISO 10582	Compact Resilient Floorcovering
CE certification	EN 14041	Yes
Classification	EN ISO 10874	Domestic: 23 Commercial: 32 Industrial: 41
TECHNICAL CHARACTERISTICS	STANDARDS	iD Selection 40
Tota thickness	EN ISO 24346	2.2
Wear layer thickness	EN ISO 24340	0.4
Surface treatment (PUR)	-	Yes - TopCleanXP™
Beveled edges	-	No
Total weight	EN ISO 23997	3650 g/m ²
Wear layer binder content	ISO 10582	Type I
Form of delivery	EN ISO 24342	
	Planks	16,66 x 100 cm, 27 planks/box = 4,50 m ² 20 x 122 cm, 18 planks/box = 4,39 m ² 25 x 122 cm, 14 planks/box = 4,27 m ²
	Tiles	50 x 50 cm, 18 tiles/box = 4,50 m ² 30,5 x 61 cm, 23 tiles/box = 4,28 m ² 61 x 61 cm, 11 tiles/box = 4,09 m ²
TECHNICAL PERFORMANCES	STANDARDS	iD Selection 40
Dimensional stability	EN ISO 23999	≤ 0,10 %
Reaction to fire	EN 13501-1	Bfl-s1 glued over concrete substrate Cfl-s1 glued over wood substrate
Residual indentation	EN ISO 24343-1	≤ 0,05 mm
Furniture leg	EN 424	No damage
Castor chair	ISO 4918	No damage
Curl resultant to heat	EN ISO 23999	≤ 2 mm
Underfloor heating	-	Suitable - max. 27 °C
Thermal resistance	ISO 10456	0,02 m ² K/W
Impact sound reduction	EN ISO 717-2	2 dB
Reduction of in room impact noise	NF EN ISO 31-074	Class C (Ln,e,w < 85 dB)
Light fastness	EN ISO 105-B02 Method 3	≥ 6
Resistance to chemicals	EN ISO 26987	High resistance
Slip resistance	DIN 51130 EN 13893	R9 μ ≥ 0,30
Electrical properties	EN 1815 EN 1081	<2 kV on concrete ≥ 10 ⁹ Ohm
Colours		30

Technical data in force upon the date of publication (11/15). The values correspond to laboratory tests (no in situ test) and are subject to modification. Tarkett's instructions regarding installation, cleaning and maintenance shall be observed. Please contact your local sales rep. for these instructions.

Our Sustainability tag explains the content of our products and how they contribute to our sustainability strategy and human well-being.

CUSTOMS TARIFF: 482050000000F

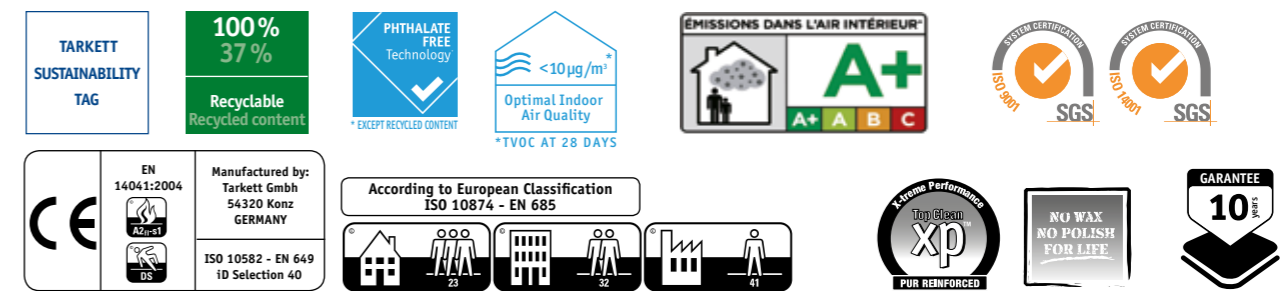

iD Inspiration 55-70

Explore limitless design possibilities in a truly modular range to create spaces that build brand image, evoke emotion and positively shape the customer's experience. Customise every aspect from design to surface structure to create unique decors. And complete your project with iD Inspiration 55-70 full set of accessories.

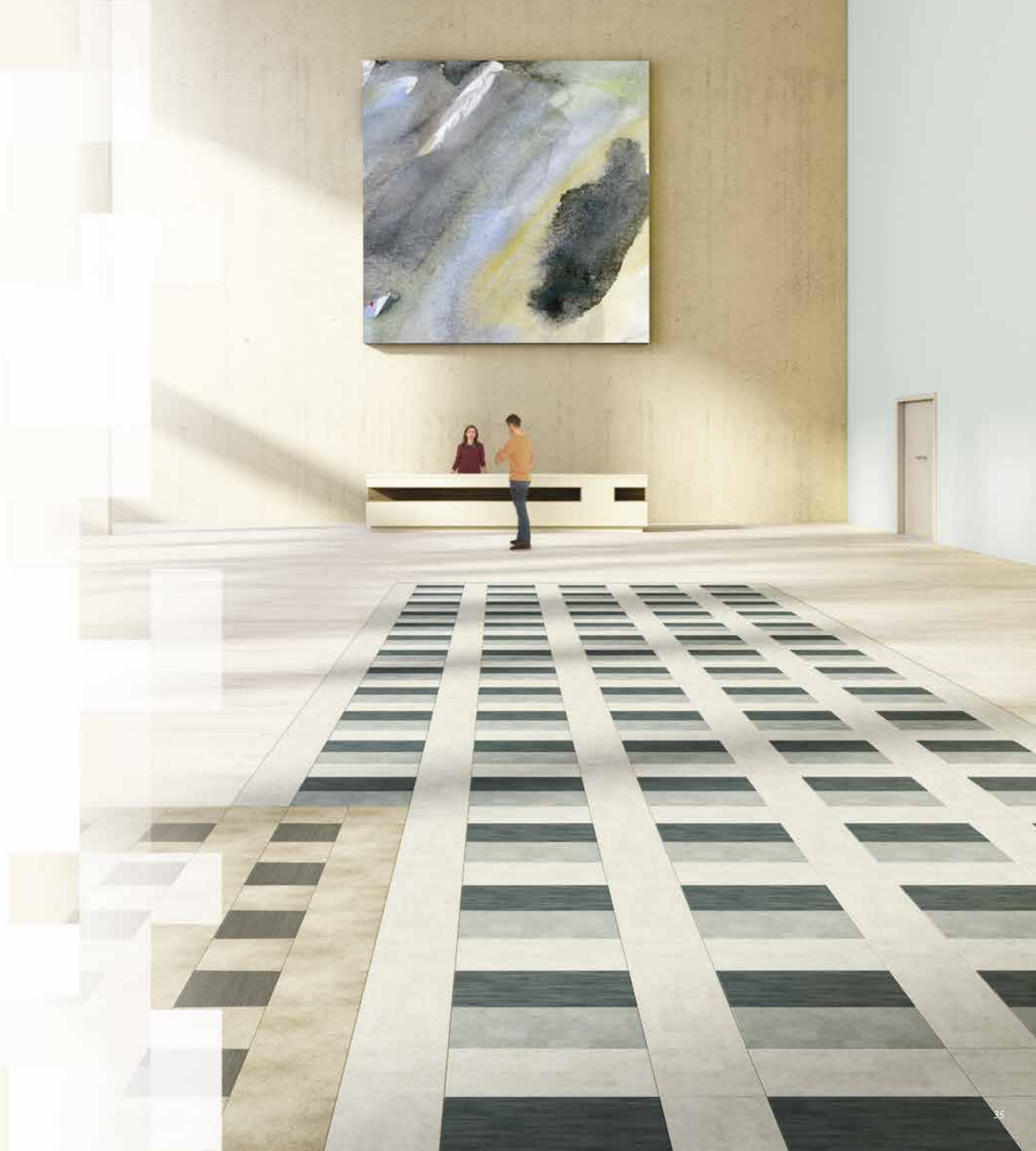



iD Inspiration 55-70

Experiment with colours and formats to create an experience out of the ordinary.



PERUVIAN BASKET

3 colours - Buy 4/7 of Silver, 2/7 of Black, 1/7 of Beige*

Uses model:

Trend Line - Silver (090)
Trend Line - Black (088)
Patine - Beige (057)

Tile format (cm): 50 x 50
Plank format (cm): 16.66 x 100



BASKET WEAVE

3 colours - Buy 2/5 of Silver, 2/5 of Black, 1/5 of Beige*

Uses model:

Trend Line - Silver (090)
Trend Line - Black (088)
Patine - Beige (057)

Tile format (cm): 50 x 50
Plank format (cm): 16.66 x 100



FRENCH GARDEN

3 colours - Buy 1/3 of each colour*

Uses models:

Patine - Beige (057)
Patine - Grey (060)
Trend Line - Black (088)

Tile format (cm): 50 x 50
Plank format (cm): 16.66 x 100



TIC TAC TOE

3 colours - Buy 1/3 of each colour*

Uses models:

Patine - Black (058)
Patine - Beige (057)
Trend Line - Silver (090)

Tile format (cm): 50 x 50
Plank format (cm): 16.66 x 100



iD Inspiration 55-70

Experiment with colours and formats to create an experience out of the ordinary.



GRADIENCE

3 colours - Buy 5/12 of Black, 3/12 of Grey, 4/12 of white*

Uses models:

White Oak - Light (102)
White Oak - Black (099)
White Oak - Grey (101)

Plank format (cm): 20 x 122



BARCODE

2 colours - Buy 5/12 of Black, 7/12 of White*

Uses models:

White Oak - Light (102)
White Oak - Black (099)

Plank format (cm): 20 x 122



ROYAL ALLEY

3 colours - Buy 3/8 of White, 3/8 of Grey, 2/8 of Black*

Uses models:

White Oak - Light (102)
White Oak - Grey (101)
White Oak - Black (099)

Plank format (cm): 20 x 122



GARDEN ALLEY

2 colours - Buy 4/5 of White, 1/5 of Grey*

Uses models:

White Oak - Light (102)
White Oak - Grey (101)

Plank format (cm): 20 x 122

WOOD



ANTIK OAK - DARK GREY

iD 55 4621 003 iD 70 4663 003
20 x 122 cm
iD 55 4621 003 iD 70 4663 003
25 x 150 cm
LRV: 25.33%



ANTIK OAK - BROWN

iD 55 4621 002 iD 70 4663 002
20 x 122 cm
iD 55 4622 002 iD 70 4664 002
25 x 150 cm
LRV: 18.21%



ANTIK OAK - GREY

iD 55 4621 004 iD 70 4663 004
20 x 122 cm
iD 55 4622 004 iD 70 4664 004
25 x 150 cm
LRV: 32.24%



ANTIK OAK - NATURAL

iD 55 4621 005 iD 70 4663 005
20 x 122 cm
iD 55 4622 005 iD 70 4664 005
25 x 150 cm
LRV: 20.53%



OLD OAK - LIGHT

iD 55 4623 056 iD 70 4665 056
25 x 122 cm
LRV: 36.49%



CONCRETE WOOD - BLACK

iD 55 4623 017 iD 70 4665 017
25 x 122 cm
LRV: 8.32%



CONCRETE WOOD - BROWN

iD 55 4623 018 iD 70 4665 018
25 x 122 cm
LRV: 16.26%



CONCRETE WOOD - GREY

iD 55 4623 019 iD 70 4665 019
25 x 122 cm
LRV: 28.26%



ANTIK OAK - BEIGE

iD 55 4621 001 iD 70 4663 001
20 x 122 cm
iD 55 4622 001 iD 70 4664 001
25 x 150 cm
LRV: 25.94%



ENGLISH OAK - BROWN

iD 55 4621 025 iD 70 4663 025
20 x 122 cm
LRV: 14.46%



ENGLISH OAK - NATURAL

iD 55 4621 027 iD 70 4663 027
20 x 122 cm
LRV: 24.89%



ENGLISH OAK - BEIGE

iD 55 4621 024 iD 70 4663 024
20 x 122 cm
LRV: 28.80%



FARMHOUSE OAK - VINTAGE

iD 55 4623 031 iD 70 4665 031
25 x 122 cm
LRV: 28.64%



BRUSHED PINE - BROWN

iD 55 4621 013 iD 70 4663 013
20 x 122 cm
iD 55 4622 013 iD 70 4664 013
25 x 150 cm
LRV: 18.99%



BRUSHED PINE - GREY

iD 55 4621 014 iD 70 4663 014
20 x 122 cm
iD 55 4622 014 iD 70 4664 014
25 x 150 cm
LRV: 26.70%



BRUSHED PINE - NATURAL

iD 55 4621 015 iD 70 4663 015
20 x 122 cm
iD 55 4622 015 iD 70 4664 015
25 x 150 cm
LRV: 29.09%



ENGLISH OAK - LIGHT

iD 55 4621 026 iD 70 4663 026
20 x 122 cm
LRV: 25.59%



OLD OAK - BLACK

iD 55 4623 054 iD 70 4665 054
25 x 122 cm
LRV: 5.57%



OLD OAK - BROWN

iD 55 4623 055 iD 70 4665 055
25 x 122 cm
LRV: 7.14%



OLD OAK - BEIGE

iD 55 4623 053 iD 70 4665 053
25 x 122 cm
LRV: 23.88%



BRUSHED PINE - WHITE

iD 55 4621 016 iD 70 4663 016
20 x 122 cm
iD 55 4622 016 iD 70 4664 016
25 x 150 cm
LRV: 37.33%



EXOTIC WOOD - BROWN

iD 55 4620 028 iD 70 4662 028
16,66 x 100 cm
LRV: 7.01%



EXOTIC WOOD - RED

iD 55 4620 030 iD 70 4662 030
16,66 x 100 cm
LRV: 9.94%



EXOTIC WOOD - NATURAL

iD 55 4620 029 iD 70 4662 029
16,66 x 100 cm
LRV: 15.14%

WOOD



GOLDEN CHERRY - NATURAL
 iD 55 4620 032 iD 70 4662 032
 16,66 x 100 cm
 LRV: 23.33%



LARGE BEECH - NATURAL
 iD 55 4620 036 iD 70 4662 036
 16,66 x 100 cm
 LRV: 29.46%



MAPLE - NATURAL
 iD 55 4620 038 iD 70 4662 038
 16,66 x 100 cm
 LRV: 47.68%



OAK - NATURAL
 iD 55 4620 052 iD 70 4662 052
 16,66 x 100 cm
 LRV: 29.48%



MODERN OAK - BROWN
 iD 55 4621 039 iD 70 4663 039
 20 x 122 cm
 LRV: 9.54%



MODERN OAK - NATURAL
 iD 55 4621 045 iD 70 4663 045
 20 x 122 cm
 LRV: 32.57%



MODERN OAK - GREGE
 iD 55 4621 042 iD 70 4663 042
 20 x 122 cm
 LRV: 17.53%



MODERN OAK - LIGHT
 iD 55 4621 044 iD 70 4663 044
 20 x 122 cm
 LRV: 35.01%



AUTHENTIC OAK - DARK GREY
 iD 55 4621 010 iD 70 4663 010
 20 x 122 cm
 LRV: 12.59%



AUTHENTIC OAK - GREY
 iD 55 4621 011 iD 70 4663 011
 20 x 122 cm
 LRV: 29.33%



AUTHENTIC OAK - NATURAL
 iD 55 4621 012 iD 70 4663 012
 20 x 122 cm
 LRV: 17.77%



TEAK - OILED
 iD 55 4620 081 iD 70 4662 081
 16,66 x 100 cm
 LRV: 7.50%



MODERN OAK - DARK GREY
 iD 55 4621 041 iD 70 4663 041
 20 x 122 cm
 LRV: 14.56%



MODERN OAK - SILVER
 iD 55 4621 046 iD 70 4663 046
 20 x 122 cm
 LRV: 14.14%



MODERN OAK - GREY
 iD 55 4621 043 iD 70 4663 043
 20 x 122 cm
 LRV: 19.71%



WENGE - BLACK
 iD 55 4620 097 iD 70 4662 097
 16,66 x 100 cm
 LRV: 6.14%



NATURAL WALNUT - BROWN
 iD 55 4621 049 iD 70 4663 049
 20 x 122 cm
 LRV: 11.62%



NATURAL WALNUT - CLASSIC
 iD 55 4621 050 iD 70 4663 050
 20 x 122 cm
 LRV: 17.39%



NATURAL WALNUT - YELLOW
 iD 55 4621 051 iD 70 4663 051
 20 x 122 cm
 LRV: 31.45%



MODERN OAK - DARK BROWN
 iD 55 4621 040 iD 70 4663 040
 20 x 122 cm
 LRV: 9.07%



WENGE - NATURAL
 iD 55 4620 098 iD 70 4662 098
 16,66 x 100 cm
 LRV: 6.60%



SOFT WALNUT - DARK BROWN
 iD 55 4620 075 iD 70 4662 075
 16,66 x 100 cm
 LRV: 15.68%



SOFT WALNUT - BROWN
 iD 55 4620 074 iD 70 4662 074
 16,66 x 100 cm
 LRV: 12.41%



SOFT WALNUT - NATURAL
 iD 55 4620 076 iD 70 4662 076
 16,66 x 100 cm
 LRV: 27.22%

WOOD



WHITE OAK - BLACK

iD 55 4621 099 iD 70 4663 099
20 x 122 cm
LRV: 8.16%



WHITE OAK - BROWN

iD 55 4621 100 iD 70 4663 100
20 x 122 cm
LRV: 18.15%



WHITE OAK - GREY

iD 55 4621 101 iD 70 4663 101
20 x 122 cm
LRV: 28.36%



WHITE OAK - LIGHT

iD 55 4621 102 iD 70 4663 102
20 x 122 cm
LRV: 42.70%



VINTAGE TEAK - BROWN

iD 55 4623 091 iD 70 4665 091
25 x 122 cm
LRV: 8.28%

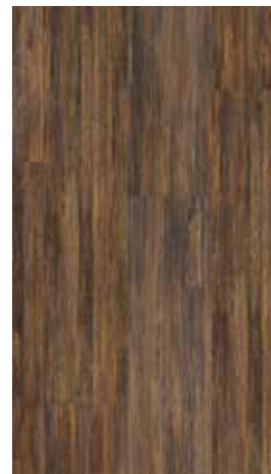

VINTAGE TEAK - NATURAL

iD 55 4623 093 iD 70 4665 093
25 x 122 cm
LRV: 9.79%



VINTAGE TEAK - GREY

iD 55 4623 092 iD 70 4665 092
25 x 122 cm
LRV: 15.92%

AUTHENTIC STONE



ANTIK STONE - BLACK

iD 55 4625 007 iD 70 4667 007
50 x 50 cm
LRV: 4.80%



ANTIK STONE - GREY

iD 55 4625 009 iD 70 4667 009
50 x 50 cm
LRV: 27.06%



ANTIK STONE - BROWN

iD 55 4625 008 iD 70 4667 008
50 x 50 cm
LRV: 16.65%



ANTIK STONE - BEIGE

iD 55 4625 006 iD 70 4667 006
50 x 50 cm
LRV: 27.97%



ROCK - BLACK

iD 55 4625 063 iD 70 4667 063
50 x 50 cm
LRV: 9.12%



ROCK - GREGE

iD 55 4625 065 iD 70 4667 065
50 x 50 cm
LRV: 46.35%



ROCK - BROWN

iD 55 4625 064 iD 70 4667 064
50 x 50 cm
LRV: 16.61%



ROCK - BEIGE

iD 55 4625 062 iD 70 4667 062
50 x 50 cm
LRV: 41.48%



SOFT STONE - BLACK

iD 55 4625 072 iD 70 4667 072
50 x 50 cm
LRV: 8.71%



SOFT STONE - GREY

iD 55 4625 073 iD 70 4667 073
50 x 50 cm
LRV: 41.50%



SOFT STONE - BEIGE

iD 55 4625 071 iD 70 4667 071
50 x 50 cm
LRV: 39.51%



TIVOLI TRAVERTINE - BEIGE

iD 55 4624 085 iD 70 4666 085
30,5 x 61 cm
LRV: 52.09%

AUTHENTIC STONE



RUSTIC SLATE - BLACK

iD 55 4626 069 iD 70 4668 069
61 x 61cm
iD 55 4627 069 iD 70 4669 069
61 x 91,5cm
LRV: 6,73%



RUSTIC SLATE - NATURAL

iD 55 4626 070 iD 70 4668 070
61 x 61cm
iD 55 4627 070 iD 70 4669 070
61 x 91,5cm
LRV: 14,28%



TRAVERTINO - BEIGE

iD 55 4624 086 iD 70 4666 086
30,5 x 61cm
LRV: 40,36%



TRAVERTINO - LIGHT

iD 55 4624 087 iD 70 4666 087
30,5 x 61cm
LRV: 46,32%

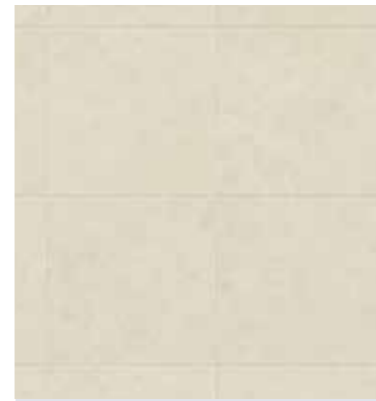

PATINE - BEIGE

iD 55 4625 057 iD 70 4667 057
50 x 50 cm
LRV: 49,93%

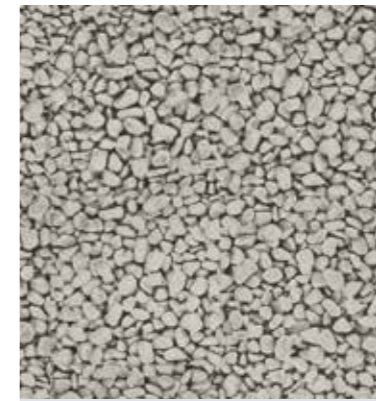

PEBBLE - NATURAL

iD 55 4625 061 iD 70 4667 061
50 x 50 cm
LRV: 35,87%



LEATHER - CAMEL

iD 55 4625 037 iD 70 4667 037
50 x 50 cm
LRV: 8,56%

MATERIAL EFFECT



TISSÉ - BLACK

iD 55 4625 083 iD 70 4667 083
50 x 50 cm
LRV: 6,08%



TISSÉ - BEIGE

iD 55 4625 082 iD 70 4667 082
50 x 50 cm
LRV: 19,52%



TISSÉ - LIGHT

iD 55 4625 084 iD 70 4667 084
50 x 50 cm
LRV: 32,83%



RUST METAL - BLACK

iD 55 4624 066 iD 70 4666 066
30,5 x 61 cm
LRV: 12,31%



RUST METAL - SILVER

iD 55 4624 068 iD 70 4666 068
30,5 x 61 cm
LRV: 13,58%



RUST METAL - COPPER

iD 55 4624 067 iD 70 4666 067
30,5 x 61 cm
LRV: 15,92%



VINTAGE ZINC - BLACK

iD 55 4624 094 iD 70 4666 094
30,5 x 61 cm
LRV: 4,51%



PATINE - BLACK

iD 55 4625 058 iD 70 4667 058
50 x 50 cm
LRV: 7,53%



PATINE - GREY

iD 55 4625 060 iD 70 4667 060
50 x 50 cm
LRV: 24,70%



PATINE - BROWN

iD 55 4625 059 iD 70 4667 059
50 x 50 cm
LRV: 26,70%



VINTAGE ZINC - SILVER

iD 55 4624 096 iD 70 4666 096
30,5 x 61 cm
LRV: 12,11%

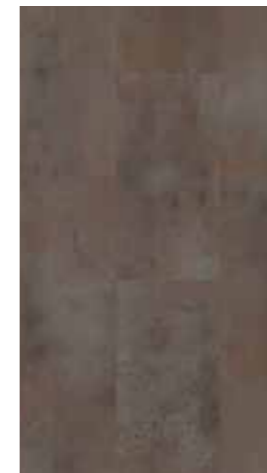

VINTAGE ZINC - RUST

iD 55 4624 095 iD 70 4666 095
30,5 x 61 cm
LRV: 10,19%

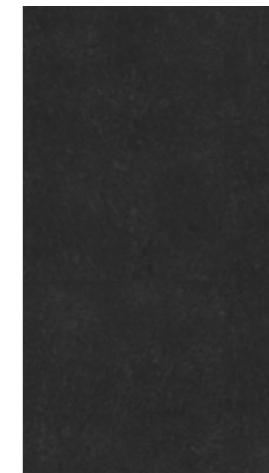

MODERN SLATE - BLACK

iD 55 4626 047 iD 70 4668 047
61 x 61 cm
iD 55 4627 047 iD 70 4669 047
61 x 91,5 cm
LRV: 3,07%



MODERN SLATE - WHITE

iD 55 4626 048 iD 70 4668 048
61 x 61 cm
iD 55 4627 048 iD 70 4669 048
61 x 91,5 cm
LRV: 57,24%

DESIGN EFFECT



TRENDLINE - BLACK
 iD 55 4620 088 iD 70 4662 088
 16,66 x 100 cm
 iD 55 4625 088 iD 70 4667 088
 50 x 50 cm
 LRV: 11.42%



TRENDLINE - SILVER
 iD 55 4620 090 iD 70 4662 090
 16,66 x 100 cm
 iD 55 4625 090 iD 70 4667 090
 50 x 50 cm
 LRV: 25.05%



TRENDLINE - INTERFERENTIAL
 iD 55 4620 089 iD 70 4662 089
 16,66 x 100 cm
 iD 55 4625 089 iD 70 4667 089
 50 x 50 cm
 LRV: 10.88%



CREATIVE WOOD - BLACK
 iD 55 4620 020 iD 70 4662 020
 16,66 x 100 cm
 LRV: 9.94%



CREATIVE WOOD - WHITE
 iD 55 4620 021 iD 70 4662 021
 16,66 x 100 cm
 LRV: 36.13%



GRAPHIC - BLACK
 iD 55 4625 033 iD 70 4667 033
 50 x 50 cm
 LRV: 2.77%



GRAPHIC - INTERFERENTIAL
 iD 55 4625 034 iD 70 4667 034
 50 x 50 cm
 LRV: 4.85%



DECOSTEEL - GREY
 iD 55 4625 022 iD 70 4667 022
 50 x 50 cm
 LRV: 27.26%

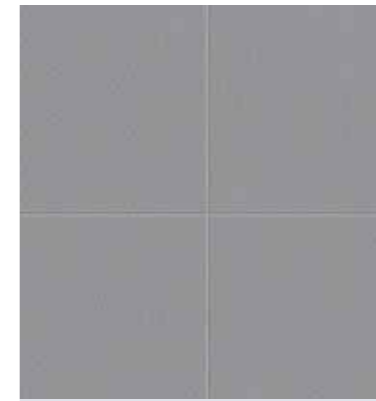

DECOSTEEL - LIGHT GREY
 iD 55 4625 023 iD 70 4667 023
 50 x 50 cm
 LRV: 15.12%



DECOSTEEL - INTERFERENTIAL
 iD 55 4625 079 iD 70 4667 079
 50 x 50 cm
 LRV: 4.89%



iD Inspiration 55-70

iD Inspiration offers over 75,000 potential combinations to play with perceptions of space, light and effects through your choice of format, design, surface structure and beveling. Every aspect of the product is fully customisable with all 101 decors.

ACCESSORY PACKAGES

- Comes with a complete range of accessories for user safety, efficient installation and project completion.
- Quick and easy installation for a long-lasting solution.

GREAT RESISTANCE AND EASY CLEANING

- Treated with TopClean XP™ surface protection that hardens the surface and simplifies cleaning and maintenance through reduced use of water, energy and chemical detergents.

SUSTAINABLE DESIGN

- Contributes to people's well-being and can be reused at end-of-life in other products.
- REACH compliant, made from 50% natural and 37% recycled material and is 100% recyclable.

LIFE-LONG PERFORMANCE

- Highly resistant to the daily wear and tear of even the most demanding commercial areas.
- 10 years limited guarantee for commercial use and 15 years limited guarantee for residential use.

OPTIMAL INDOOR AIR QUALITY

- 100% recyclable.
- Contributes to improved indoor air quality with VOC emissions below quantifiable level, less than 10ug/m³ after 28 days.
- Uses a phthalate-free technology, based on alternative plasticizers that can be used for sensitive applications such as the production of toys, food packaging and medical devices.

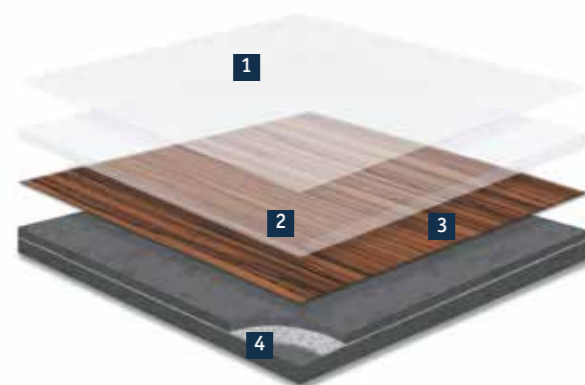

1. TopClean XP™ PUR reinforcement
Excellent resistance to abrasion, scuffs and scratches + easy/low cost maintenance

2. 0.70 mm (or 0.55 mm) pure PVC transparent wear layer
Exceptionally hard wearing and indentation resistant

3. More than 100 design options in high definition print
With great customisation possibilities

4. Unique structure reinforced with non-woven glass fibre
Exceptional dimensional stability and excellent resistance to indentation and tearing



Choose your level of customisation

With iD Inspiration, you decide on the level of design flexibility and customisation for the specific needs of your commercial project.

WOOD			5 format options (in cm)						
			Other embossing	16.66x100	16.66x122	20x122	25x122	25x150	Full Customization
Designs	Colours	Embossing							
ANTIK OAK	(5 colours)	Rustic	[C]	[B]	[A]	✓	[A]	✓	[D]
AUTHENTIC OAK	(3 colours)	Rustic	[C]	[B]	[A]	✓	[A]	[B]	[D]
BRUSHED PINE	(4 colours)	Rustic	[C]	[B]	[A]	✓	[A]	✓	[D]
CONCRETE WOOD	(3 colours)	Rustic	[C]	[B]	[A]	[A]	✓	[B]	[D]
CREATIVE WOOD	(2 colours)	Flat	[C]	✓	[B]	[B]	[B]	[B]	[D]
ENGLISH OAK	(4 colours)	Natural	[C]	[B]	[A]	✓	[A]	[B]	[D]
EXOTIC WOOD	(3 colours)	Soft wood	[C]	✓	[B]	[B]	[B]	[B]	[D]
FARMHOUSE OAK	(1 colour)	Rustic	[C]	[B]	[A]	[A]	✓	[B]	[D]
GOLDEN CHERRY	(1 colour)	Soft wood	[C]	✓	[B]	[B]	[B]	[B]	[D]
LARGE BEECH	(1 colour)	Soft wood	[C]	✓	[B]	[B]	[B]	[B]	[D]
MAPLE	(1 colour)	Soft wood	[C]	✓	[B]	[B]	[B]	[B]	[D]
MODERN OAK	(8 colours)	Natural	[C]	[B]	[A]	✓	[A]	[B]	[D]
NATURAL WALNUT	(3 colours)	Soft wood	[C]	[B]	[A]	✓	[A]	[B]	[D]
OAK	(1 colour)	Wheathered	[C]	✓	[B]	[B]	[B]	[B]	[D]
OLD OAK	(4 colours)	Rustic	[C]	[B]	[A]	[A]	✓	[B]	[D]
SOFT WALNUT	(3 colours)	Soft wood	[C]	✓	[B]	[B]	[B]	[B]	[D]
TEAK	(1 colour)	Soft wood	[C]	✓	[B]	[B]	[B]	[B]	[D]
TRENDLINE	(3 colours)	Brushed alu	[C]	✓	[B]	[B]	[B]	[B]	[D]
VINTAGE TEAK	(3 colours)	Wheathered	[C]	[B]	[A]	[A]	✓	[B]	[D]
WENGE	(2 colours)	Soft wood	[C]	✓	[B]	[B]	[B]	[B]	[D]
WHITE OAK	(4 colours)	Natural	[C]	[B]	[A]	✓	[A]	[B]	[D]

STONE, GRAPHIC & MATERIAL EFFECT			6 format options (in cm)							
			Other embossing	50x50	30.5x61	61x61	61x91.5	30.5x91.5	30.5x30.5	Full Customisation
Designs	Colours	Embossing								
ANTIK STONE	(4 colours)	Concrete	[C]	✓	[B]	[B]	[B]	[B]	[B]	[D]
DECOSTEEL	(3 colours)	Decosteel	[C]	✓	[B]	[B]	[B]	[B]	[B]	[D]
GRAPHIC	(2 colours)	Graphic	[C]	✓	[B]	[B]	[B]	[B]	[B]	[D]
LEATHER	(1 colour)	Leather	[C]	✓	[B]	[B]	[B]	[B]	[B]	[D]
MODERN SLATE	(2 colours)	Slate	[C]	[B]	[A]	✓	✓	[A]	[A]	[D]
PATINE	(4 colours)	Concrete	[C]	✓	[B]	[B]	[B]	[B]	[B]	[D]
PEBBLE	(1 colour)	Flat	[C]	✓	[B]	[B]	[B]	[B]	[B]	[D]
ROCK	(4 colours)	Stone	[C]	✓	[B]	[B]	[B]	[B]	[B]	[D]
RUSTIC SLATE	(2 colours)	Slate	[C]	[B]	[A]	✓	✓	[A]	[A]	[D]
RUST METAL	(3 colours)	Flat	[C]	[B]	✓	[A]	[A]	[A]	[A]	[D]
SOFT STONE	(3 colours)	Stone	[C]	✓	[B]	[B]	[B]	[B]	[B]	[D]
TISSÉ	(3 colours)	Texstyle	[C]	✓	[B]	[B]	[B]	[B]	[B]	[D]
TIVOLI TRAVERTINE	(1 colour)	Stone	[C]	[B]	✓	[A]	[A]	[A]	[A]	[D]
TRAVERTINO	(2 colours)	Stone	[C]	[B]	✓	[A]	[A]	[A]	[A]	[D]
TRENDLINE	(3 colours)	Brushed alu	[C]	✓	[B]	[B]	[B]	[B]	[B]	[D]
VINTAGE ZINC	(3 colours)	Flat	[C]	[B]	✓	[A]	[A]	[A]	[A]	[D]

LEGEND



STANDARD OPTION:
In stock - no minimum quantity.

[A]
BEVELING OR
REGULAR
FORMAT CHANGES

Make to order
Min 100 sqm.

[B]
SPECIAL
FORMAT CHANGES

Make to order
Min. 700 sqm.

[C]
EMBOSSING
CHANGES

Make to order
Min. 1100 sqm.

[D]
FULL CUSTOM

Colour, format, beveling,
embossing changes
Make to order
Min. 1500 sqm.



Individualised designs with Floorcraft service

For projects looking for individually customised design with logos, brand colours or other visual elements, Tarkett Floorcraft Service is ready to translate your ideas into unique flooring concepts. Designs can be tailored to the aesthetic and commercial requirements and shape of any floor area. Floorcraft designs are assembled in the factory and sent on-site. Detailed layout plans make it fast and simple to install.



FLOORCRAFT OFFERS:

An off the shelf library of patterns immediately available in a selection of 6 colour options to enhance borders and provide wayfinding features.

A bank of design options in any size in a selection of 20 colour options to highlight interior features and zoning.

A fully customised solution to match your choice of design and colour, for a more individualised flooring environment.

For more information: <http://professionals.tarkett.com/content/floorcraft-design-service>

Feature strip

Create visual effects with contrasts of colours - to highlight interior features, shape perceptions of room size or personalise your flooring design in plank or tile arrangements.

iD Inspiration 55-70 comes with 9 coloured feature lines for more creative design possibilities.

BLACK	1421 001
SILVER	1421 002
COPPER	1421 003
PHOSPHORESCENT	1421 005
GREEN	1421 006
TAUPE	1421 007
TOBACCO	1421 008
DARK GREY	1421 009
RED	1421 010



Accessories

Skirting



1 PVC DECORATIVE SKIRTING

Compact skirting with decorative film and PUR surface treatment. Perfect matching with 22 iD Inspiration 55-70 references, see column 2 in the skirting chart p.57 (10 x 60 x 2020 mm). Ordering unit: 16 units of 2.02 lm.



2 RIGID DECORATIVE SKIRTING WITH MATERIAL TO BE INSERTED

1448 ---
IS 60
(For straight walls, 10 x 60 x 2570 mm, 3 colours available).
Ordering unit: 20 units of 2.5 lm.

1462 ---
ISS 60
(for straight walls, 20 x 120 x 2570 mm, 6 colours available).
Ordering unit: 20 units of 2.5 lm.

Also available in flexible decorative skirtings (7 x 60 x 2500 mm).



3 LARGE DECORATIVE SKIRTING

8025 ---
Large laminate skirting (17 x 60 x 2400 mm, 21 LVT resembling colours available).
Ordering unit: 10 units of 2.4 lm.
Fixing system available: plastic clip holders.

Underlay

TARKOFLAT LOOSE-LAY

Ready-to-use solution

- Reduces slight unevenness in older subfloors by up to 1.5mm depth and 3mm width
- Prevents telegraphic effect, the appearance of bumps and ridges from the substrate by up to 1.5mm depth
- Residential and light traffic commercial applications (Class 32 max.)

Quick and easy to install*

Ref.: 3568 004 - Grey



Design & Colours	Art.	1	2	3
ANTIK OAK-BEIGE	001	26640 001	-	8025 217
ANTIK OAK-BROWN	002	26640 002	1462 004	8025 323
ANTIK OAK-DARK GREY	003	26640 003	-	8025 355
ANTIK OAK-GREY	004		-	8025 326
ANTIK OAK-NATURAL	005	26640 005	1462 006	8025 214
ANTIK STONE-BEIGE	006		1462 006	-
ANTIK STONE-BLACK	007		1462 001	8025 283
ANTIK STONE-BROWN	008		-	-
ANTIK STONE-GREY	009		-	-
AUTHENTIC OAK-DARK GREY	010		-	8025 355
AUTHENTIC OAK-GREY	011		-	8025 326
AUTHENTIC OAK-NATURAL	012		1462 006	8025 214
BRUSHED PINE-BROWN	013	26640 013	1462 006	8025 327
BRUSHED PINE-GREY	014	26640 014	1462 006	8025 129
BRUSHED PINE-NATURAL	015		1462 005	8025 214
BRUSHED PINE-WHITE	016		-	8025 326
CONCRETE WOOD-BLACK	017		1462 001	8025 239
CONCRETE WOOD-BROWN	018		-	8025 355
CONCRETE WOOD-GREY	019		-	8025 326
CREATIVE WOOD-BLACK	020		1462 001	8025 239
CREATIVE WOOD-WHITE	021		1462 001	8025 240
DECOSTEEL-GREY	022		1462 001	-
DECOSTEEL-INTERFERENTIAL	079		1462 002	-
DECOSTEEL-LIGHT GREY	023		1462 002	-
ENGLISH OAK-BEIGE	024	26640 024	-	8025 129
ENGLISH OAK-BROWN	025	26640 025	-	8025 197
ENGLISH OAK-LIGHT	026	26640 026	1462 005	8025 217
ENGLISH OAK-NATURAL	027	26640 027	1462 005	8025 006
EXOTIC WOOD-BROWN	028		1462 004	8025 216
EXOTIC WOOD-NATURAL	029		1462 006	8025 220
EXOTIC WOOD-RED	030		1462 004	8025 279
FARMHOUSE OAK-VINTAGE	031		1462 005	8025 214
GOLDEN CHERRY-NATURAL	032		1462 006	8025 011
GRAPHIC-BLACK	033		1462 001	-
GRAPHIC-INTERFERENTIAL	034		1462 002	-
LARGE BEECH-NATURAL	036		1462 005	8025 006
LEATHER-CAMEL	037		1462 004	-
MAPLE-NATURAL	038		1462 005	8025 035
MODERN OAK-BROWN	039		1462 006	8025 197
MODERN OAK-DARK BROWN	040		1462 001	8025 239
MODERN OAK-DARK GREY	041		1462 004	8025 323
MODERN OAK-GREGE	042		1462 006	8025 327
MODERN OAK-GREY	043	26640 043	1462 006	8025 129
MODERN OAK-LIGHT	044	26640 044	-	8025 326
MODERN OAK-NATURAL	045	26640 045	1462 005	8025 214
MODERN OAK-SILVER	046		1462 001	8025 239
MODERN SLATE-BLACK	047		1462 001	8025 283
MODERN SLATE-WHITE	048		-	-

Design & Colours	Art.	1	2	3
NATURAL WALNUT-BROWN	049		1462 006	8025 216
NATURAL WALNUT-CLASSIC	050	26640 050	1462 006	8025 323
NATURAL WALNUT-YELLOW	051	26640 051	1462 005	8025 006
OAK-NATURAL	052	26640 052	1462 005	8025 006
OLD OAK-BEIGE	053		1462 006	8025 129
OLD OAK-BLACK	054		1462 001	8025 239
OLD OAK-BROWN	055		1462 004	8025 303
OLD OAK-LIGHT	056		1462 002	8025 326
PATINE-BEIGE	057		-	-
PATINE-BLACK	058		1462 001	8025 283
PATINE-BROWN	059		-	-
PATINE-GREY	060		1462 002	8025 281
PEBBLE-NATURAL	061		1462 001	-
ROCK-BEIGE	062		1462 006	-
ROCK-BLACK	063		1462 001	8025 283
ROCK-BROWN	064		1462 006	-
ROCK-GREGE	065		1462 006	-
RUST METAL-BLACK	066		1462 001	8025 283
RUST METAL-COPPER	067		1462 006	-
RUST METAL-SILVER	068		-	8025 283
RUSTIC SLATE-BLACK	069		1462 001	8025 283
RUSTIC SLATE-NATURAL	070		-	-
SOFT STONE-BEIGE	071		1462 006	-
SOFT STONE-BLACK	072		1462 001	8025 283
SOFT STONE-GREY	073		1462 002	8025 284
SOFT WALNUT-BROWN	074	26640 074	1462 004	8025 279
SOFT WALNUT-DARK BROWN	075		1462 006	8025 327
SOFT WALNUT-NATURAL	076	26640 076	1462 005	8025 006
TEAK-OILED	081		1462 006	8025 220
TISSE-BEIGE	082		-	-
TISSE-BLACK	083		1462 001	-
TISSE-LIGHT	084		-	-
TIVOLI TRAVERTINE-BEIGE	085		-	-
TRAVERTINO-BEIGE	086		1462 006	-
TRAVERTINO-LIGHT	087		-	-
TRENDLINE-BLACK	088		1462 001	-
TRENDLINE-INTERFERENTIAL	089		1462 002	-
TRENDLINE-SILVER	090		1462 002	-
VINTAGE TEAK-BROWN	091		1462 001	8025 303
VINTAGE TEAK-GREY	092	26640 092	1462 006	8025 355
VINTAGE TEAK-NATURAL	093	26640 093	-	8025 197
VINTAGE ZINC-BLACK	094		1462 001	8025 283
VINTAGE ZINC-RUST	095		1462 006	-
VINTAGE ZINC-SILVER	096		1462 002	8025 283
WENGE-BLACK	097		1462 001	8025 239
WENGE-NATURAL	098		1462 004	8025 216
WHITE OAK-BLACK	099		1462 001	8025 239
WHITE OAK-BROWN	100		1462 006	8025 323
WHITE OAK-GREY	101	26640 101	1462 002	8025 288
WHITE OAK-LIGHT	102	26640 102	1462 002	8025 240

*Tarkett recommend a selection of manufacturer adhesive (list available at: professionals.tarkett.com/content/list-recommended-adhesives). It is the responsibility of the adhesive manufacturer and flooring contractor to ensure the product being used is appropriate to use and applied in accordance with the manufacturer recommendations.

iD Inspiration 55-70

Profile

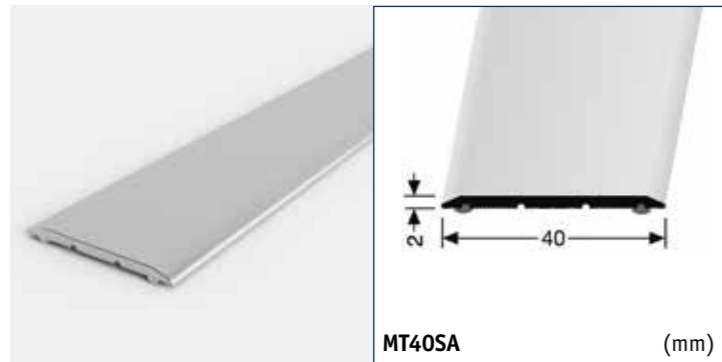

MT40SA (mm)

SELF-ADHESIVE TRANSITION PROFILE

Self-adhesive aluminium transition strip, for a perfect transition between different flooring materials. Suitable for use in heavy traffic areas.

1 colour: Ref.: Silver 1470 008
Delivery form: 10 units of 2.7 lm

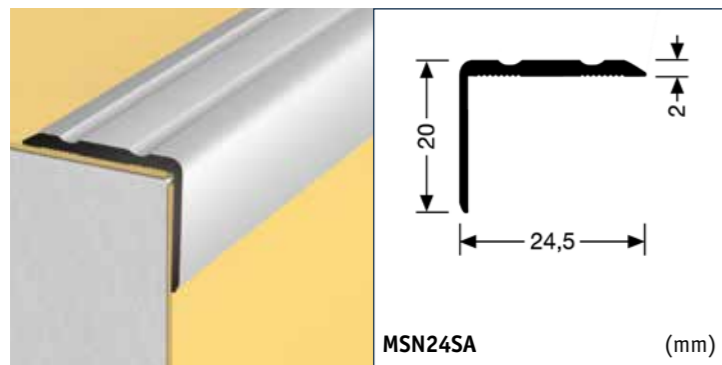

MSN24SA (mm)

TRANSITION PROFILE

Aluminium transition profile, to be screwed.

1 colour: Ref.: Silver 1480 008
Delivery form: 10 units of 2.7 lm

Accessibility



WARNING TILE

Helps recognize a change in level, in accordance with regulatory requirements for disabled access and safety. Various formats available. Self-adhesive or to be glued to the floorcovering (according to product).

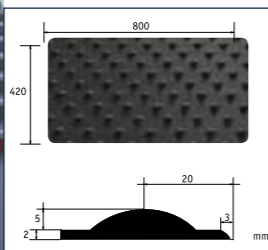

Self-adhesive rectangular tiles
Format: 815 x 420 x 8mm
Ordering unit: 1 box of 6 tiles

Self-adhesive square tiles
Format: 450 x 420 x 8mm
Ordering unit: 1 box of 20 tiles

Self-adhesive

	Rectangular tile	Square tile
White	1440 350	1440 450
Grey	1440 351	1440 451
Black	1440 352	1440 452
Ivory	1440 353	1440 453
Red	1440 354	1440 454
Yellow	1440 355	1440 455

Self-adhesive

White	1440 050
Grey	1440 051
Black	1440 052
Ivory	1440 053
Red	1440 054
Yellow	1440 055

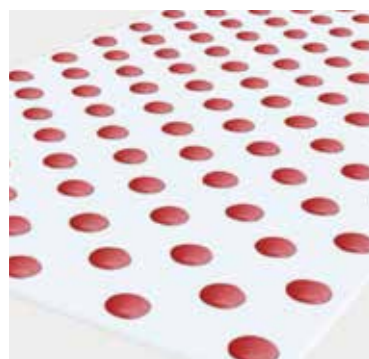

3D STUD

Ready-to-use podotactile studs to be simply fitted on top of the existing floorcovering.

Format (stud): 5 x 25mm
Ordering unit: 1 box of 200 studs

Specification

Modular vinyl floorcovering, with glass fibre reinforcement. TopClean XP™ polyurethane reinforcement. In plank and tile form, with bevelled edges. Product standard: EN ISO 10582.

CERTIFICATION & CLASSIFICATION	STANDARDS	iD Inspiration 55	iD Inspiration 70
Type of floor covering	EN ISO 10582	Compact Resilient Floorcovering	Compact Resilient Floorcovering
CE certification	EN 14041	Yes	Yes
Classification	EN ISO 10874 - EN 685	Residential: 23 Commercial: 33 Industrial: 42	Residential: 23 Commercial: 34 Industrial: 43

TECHNICAL CHARACTERISTICS	STANDARDS	iD Inspiration 55	iD Inspiration 70
Total thickness	EN ISO 24346 - EN 428	2.5 mm	2.5 mm
Wear layer thickness	EN ISO 24340 - EN 429	0.55 mm	0.70 mm
Surface treatment (PUR)		Yes	Yes
Bevelled edges		Yes	Yes
Total weight	EN ISO 23997 - EN 430	3.950 g	3.950 g
Wear layer binder content	ISO 10582	Type I	Type I
Form of delivery	EN ISO 24342 - EN 427 Planks	16.66 x 100 cm, 24 planks/box = 4 m ² 20 x 122 cm, 16 planks/box = 3.90 m ² 25 x 122 cm, 12 planks/box = 3.66 m ² 25 x 150 cm, 10 planks/box = 3.75 m ²	16.66 x 100 cm, 24 planks/box = 4 m ² 20 x 122 cm, 16 planks/box = 3.90 m ² 25 x 122 cm, 12 planks/box = 3.66 m ² 25 x 150 cm, 10 planks/box = 3.75 m ²
	EN ISO 24342 - EN 427 Tiles	50 x 50 cm, 16 tiles/box = 4 m ² 61 x 61 cm, 10 tiles/box = 3.72 m ² 30.5 x 61 cm, 20 tiles/box = 3.72 m ² 61 x 91.5 cm, 6 tiles/box = 3.35 m ²	50 x 50 cm, 16 tiles/box = 4 m ² 61 x 61 cm, 10 tiles/box = 3.72 m ² 30.5 x 61 cm, 20 tiles/box = 3.72 m ² 61 x 91.5 cm, 6 tiles/box = 3.35 m ²

TECHNICAL PERFORMANCES	STANDARDS	iD Inspiration 55	iD Inspiration 70
Dimensional stability	EN ISO 23999 - EN 434	≤ 0.10 %	≤ 0.10 %
Reaction to fire	EN 13501-1	B _{f1} s1 on concrete and C _{f1} s1 on wood substrate	B _{f1} s1 on concrete and C _{f1} s1 on wood substrate
Residual indentation	EN ISO 24343-1 - EN 433	≤ 0.05 mm	≤ 0.05 mm
Furniture leg	EN 424	No damage	No damage
Castor chair	EN ISO 4918 - EN 425	No damage	No damage
Curly resultant to heat	EN ISO 23999 - EN 434	≤ 2 mm	≤ 2 mm
Underfloor heating		Suitable – max. 27°C	Suitable – max. 27°C
Thermal resistance	EN ISO 12524	0.03 m ² K/W	0.03 m ² K/W
Impact sound reduction	EN ISO 717-2	ΔL _w = 2 dB	ΔL _w = 2 dB
Reduction of in room impact noise	NF EN ISO 31-074	Class C (L _{n,e,w} < 85dB)	Class C (L _{n,e,w} < 85dB)
Light fastness	EN ISO 105-B02	≥ 6	≥ 6
Resistance to chemicals	EN 423	High resistance	High resistance
Slip resistance	EN 13893 DIN 51130	μ ≥ 0,30 R9/R10 depending on the embossing	μ ≥ 0,30 R9/R10 depending on the embossing
Electrical properties	EN 1815 EN 1081	≤ 2kV on concrete > 10 ⁹ Ω	≤ 2kV on concrete > 10 ⁹ Ω
Adhesion wear layer	EN 431	≥ 50N / 50mm	≥ 50N / 50mm
Colours		Woods: 57 Stone, graphic and material effects: 41	Woods: 57 Stone, graphic and material effects: 41

The above information is subject to modification for the benefit of further improvement. (11/15).

Tarkett's instructions regarding installation, cleaning and maintenance should be observed. Please contact Tarkett at the address shown for these instructions. Please note that a slight colour and gloss variation can be seen between the samples on this card and the delivered material.

CUSTOMS TARIFF: 482050000000F





iD Inspiration **LIMITED EDITION**

Be inspired by iD Inspiration Limited Edition rich palette of colours and designs. Whether you favor timeless, gentle hues or striking, iridescent shades that change with the light, there's a look to match your style.



iD Inspiration LIMITED EDITION

Create and customise unique concepts for a truly distinctive look.

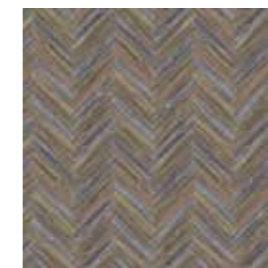

HYBRID HERRINGBONE

3 colours - Buy 1/3 of each colour*

Uses models:

Luxury Oak - Alu (109)
Luxury Oak - Bronze (110)
Luxury Oak - Gold (111)

Plank format (cm): 16.66 x 100



TIMES SQUARE

2 colours - Buy 1/2 of each colour*

Uses models:

Luxury Oak - Alu (109)
Luxury Oak - Bronze (110)

Plank format (cm): 16.66 x 100

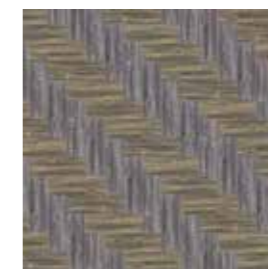

HERRINGBONE PAIR

2 colours - Buy 1/2 of each colour*

Uses models:

Luxury Oak - Alu (109)
Luxury Oak - Gold (111)

Plank format (cm): 16.66 x 100



TRENDY SQUARE

3 colours - Buy 1/3 of each colour*

Uses models:

Luxury Oak - Alu (109)
Luxury Oak - Bronze (110)
Luxury Oak - Gold (111)

Plank format (cm): 16.66 x 100

* Estimation based on this scaled square pattern



iD Inspiration LIMITED EDITION

Create and customise unique concepts for a truly distinctive look.



TUNING FORK

2 colours - Buy 1/2 of each colour*

Uses models:

Style Oak - Alu Beige (117)
Style Oak - Alu Grey (118)

Plank format (cm) : 20 x 122



TWO-STEP

2 colours - Buy 1/2 of each colour*

Uses models:

Style Oak - Alu Beige (117)
Style Oak - Alu Grey (118)

Plank format (cm) : 20 x 122



CRESCENDO

2 colours - Buy 1/2 of each colour*

Uses models:

Style Oak - Alu Beige (117)
Style Oak - Alu Grey (118)

Plank format (cm) : 20 x 122



DUAL HERRINGBONE

2 colours - Buy 1/2 of each colour*

Uses models:

Style Oak - Alu Beige (117)
Style Oak - Alu Grey (118)

Plank format (cm) : 20 x 122

* Estimation based on this scaled square pattern



iD Inspiration LIMITED EDITION

Create and customise unique concepts for a truly distinctive look.



HERRINGBONE CROSS

3 colours - Buy 1/3 of each colour*

Uses models:
Kiruma - Mouse Grey (106)
Kiruma - Slate Grey (107)
Kiruma - Dark Chocolate (108)

Plank format (cm): 20 x 122



DOUBLE HERRINGBONE

2 colours - Buy 1/2 of each colour*

Uses models:
Kiruma - Mouse Grey (106)
Kiruma - Dark Chocolate (108)

Plank format (cm): 20 x 122



GRADIENT HERRINGBONE

2 colours - Buy 1/2 of each colour*

Uses models:
Kiruma - Slate Grey (107)
Kiruma - Dark Chocolate (108)

Plank format (cm): 20 x 122



WAVE REPEAT

2 colours - Buy 1/2 of each colour*

Uses models:
Kiruma - Mouse Grey (106)
Kiruma - Slate Grey (107)

Plank format (cm): 20 x 122

* Estimation based on this scaled square pattern



iD Inspiration LIMITED EDITION

Create and customise unique concepts for a truly distinctive look.

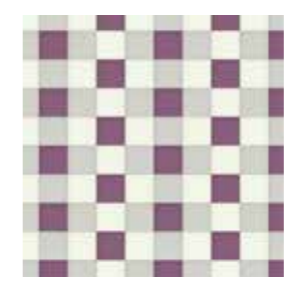

MIXED CHECKERBOARD
 3 colours - Buy 2/8 of Interferential, 3/8 of Grey, 3/8 of White*
 Uses models:
 Decosteel - White Interferential (112)
 Decosteel - Grey Interferential (113)
 Decosteel - Interferential (079)
 Tile format (cm): 50 x 50

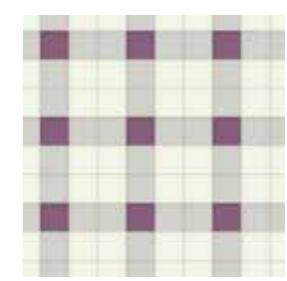

SCOTTISH TARTAN
 3 colours - Buy 2/5 of White, 2/5 of Grey, and 1/5 of Interferential*
 Uses models:
 Decosteel - White Interferential (112)
 Decosteel - Grey Interferential (113)
 Decosteel - Interferential (079)
 Tile format (cm): 50 x 50
 Add black feature strips for a scottish tartan effect

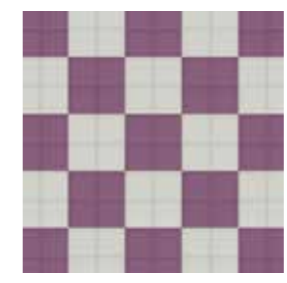

MACRO CHECKERBOARD
 2 colours - Buy 1/2 of each colour*
 Uses models:
 Decosteel - Grey Interferential (113)
 Decosteel - Interferential (079)
 Tile format (cm): 50 x 50

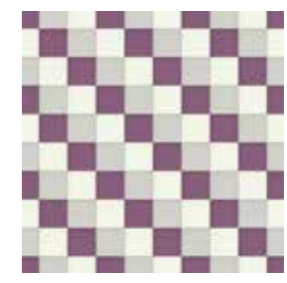

BISHOP MOVES
 3 colours - Buy 1/3 of each colour*
 Uses models:
 Decosteel - White Interferential (112)
 Decosteel - Grey Interferential (113)
 Decosteel - Interferential (079)
 Tile format (cm): 50 x 50

* Estimation based on this scaled square pattern

LUXURY

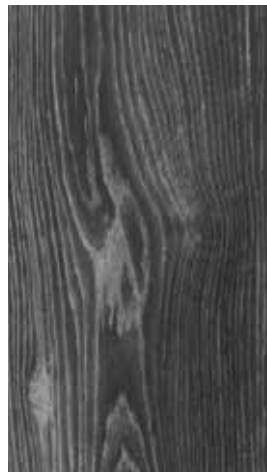

LUXURY OAK- ALU
iD 55: 4620 109 iD 70: 4662 109
LRV: 11.04% 16.6 x 100 cm



LUXURY OAK - BRONZE
iD 55: 4620 110 iD 70: 4662 110
LRV: 10.23% 16.6 x 100 cm



LUXURY OAK - GOLD
iD 55: 4620 111 iD 70: 4662 111
LRV: 15.44% 16.6 x 100 cm



TREND LINE - ALU
iD 55: 4620 114 iD 70: 4662 114
LRV: 6.08% 16.6 x 100 cm



TREND LINE - BRONZE
iD 55: 4620 115 iD 70: 4662 115
LRV: 5.48% 16.6 x 100 cm



TREND LINE - GOLD
iD 55: 4620 116 iD 70: 4662 116
LRV: 9.54% 16.6 x 100 cm

DECOSTEEL



DECOSTEEL - INTERFERENTIAL WHITE
iD 55: 4625 112 iD 70: 4667 112
LRV: 61.71% 50 x 50 cm



DECOSTEEL - INTERFERENTIAL GREY
iD 55: 4625 113 iD 70: 4667 113
LRV: 38.24% 50 x 50 cm



DECOSTEEL - INTERFERENTIAL
iD 55: 4625 079 iD 70: 4667 079
LRV: 5.02% 50 x 50 cm

SCANDINAVIAN



STYLE OAK - ALU BEIGE
iD 55: 4621 117 iD 70: 4663 117
LRV: 7.19% 20 x 122 cm



STYLE OAK - ALU GREY
iD 55: 4621 118 iD 70: 4663 118
LRV: 32.03% 20 x 122 cm



NEUTRAL



KIRUMA - DARK CHOCOLATE
iD 55: 4621 108 iD 70: 4663 108
LRV: 3.25% 20 x 122 cm



KIRUMA - SLATE GREY
iD 55: 4621 107 iD 70: 4663 107
LRV: 8.27% 20 x 122 cm



KIRUMA - MOUSE GREY
iD 55: 4621 106 iD 70: 4663 106
LRV: 29.91% 20 x 122 cm



iD Inspiration LIMITED EDITION

iD Inspiration Limited Edition has been created by our designers in Europe, drawing on the latest consumer experience trends as explored in Tarkett's Observer design study. With production expertise in Germany, we can ensure flexible manufacturing, a top quality product and a highly reactive customer service.

4 design trends

LUXURY

- Compose a warm and rich ambiance.
- Startling mix of iridescent aluminium, gold and bronze with a wood pattern.
- Gives the most creative spaces a sumptuous and eye-catching twist.
- Choose between 2 unique designs, either linear graphical or elegant oak.

DECOSTEEL

- Revisit the industrial look with a touch of elegance.
- Associating a delicate mother of pearl effect with an industrial pattern brings an astonishingly luxurious shimmer to flooring tiles.
- Iridescence makes the colour change as you move and creates the most surprising effects.

SCANDINAVIAN

- Delicate metallic beige and grey are simple and timeless hues that create a sophisticated result.
- In a plank format, with beveled edges, these two tones associate the refined shimmer of metal with an enduring wood design.
- It creates an original look that varies as you move around the room.

NEUTRAL

- Start with 3 stylish and contrasting shades of grey in beveled edges plank format.
- Mix of a delicate stone design with wood embossing.
- Create a subtle, contemporary and graphic style.

A lifetime of sustainable flooring

- 100% recyclable.
- Contributes to improved indoor air quality with VOC emissions below quantifiable level, less than 10ug/m³ after 28 days.
- Uses a phthalate-free technology, based on alternative plasticizers that can be used for sensitive applications such as the production of toys, food packaging and medical devices.

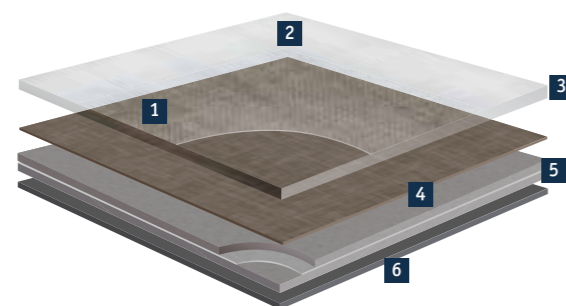

1. Surface embossing & textures:
close to real materials

2. TopClean XP™ PUR reinforcement:
extreme resistance and easy low-cost maintenance

3. 0.55/0.70mm pure PVC transparent wear layer: *exceptionally hardwearing and indentation resistant*

4. 14 design options in high definition printing: *with great customisation possibilities*

5. Unique composite structure built with solid homogeneous calandered layers reinforced with non-woven glass fibre: *exceptional dimensional stability and excellent resistance to tear and indentation*

6. PVC backing





Feature strip

Create visual effects with contrasts of colours - to highlight interior features, shape perceptions of room size or personalise your flooring design in plank or tile arrangements. iD Inspiration Limited Edition comes with 9 coloured feature lines for more creative design possibilities.

BLACK	1421 001
SILVER	1421 002
COPPER	1421 003
PHOSPHORESCENT	1421 005
GREEN	1421 006
TAUPE	1421 007
TOBACCO	1421 008
DARK GREY	1421 009
RED	1421 010

Specification

Modular vinyl floor covering, with glass fibre reinforcement. TopClean XP™ polyurethane reinforcement. In plank and tile format, with bevelled edges. Product standard: EN ISO 10582.

CERTIFICATION & CLASSIFICATION	STANDARDS	iD Inspiration Limited Edition 55	iD Inspiration Limited Edition 70
Type of floor covering	EN ISO 10582	Compact resilient floor covering	Compact resilient floor covering
CE certification	EN 14041	Yes	Yes
Classification	EN ISO 10874	Residential: 23 Commercial: 33 Industrial: 42	Residential: 23 Commercial: 34 Industrial: 43
TECHNICAL CHARACTERISTICS	STANDARDS	iD Inspiration Limited Edition 55	iD Inspiration Limited Edition 70
Total thickness	EN ISO 24346	2.5 mm	2.5 mm
Wear layer thickness	EN ISO 24340	0.55 mm	0.7 mm
Surface treatment (PUR)		Yes	Yes
Bevelled edges		Yes	Yes
Total weight	EN ISO 23997	3.950 g	3.950 g
Wear layer binder content	ISO 10582	Type I	Type I
Form of delivery	EN ISO 24342 Planks	16.66 x 100 cm, 24 planks/box = 4 m ² 20 x 122 cm, 16 planks/box = 3.90 m ²	16.66 x 100 cm, 24 planks/box = 4 m ² 20 x 122 cm, 16 planks/box = 3.90 m ²
	EN ISO 24342 Tiles	50 x 50 cm, 16 tiles/box = 4 m ²	50 x 50 cm, 16 tiles/box = 4 m ²
TECHNICAL PERFORMANCES	STANDARDS	iD Inspiration Limited Edition 55	iD Inspiration Limited Edition 70
Dimensional stability	EN ISO 23999	≤ 0.10 %	≤ 0.10 %
Reaction to fire	EN 13501-1	B _{f1} s1 on concrete and C _{f1} s1 on wood substrate	B _{f1} s1 on concrete and C _{f1} s1 on wood substrate
Residual indentation	EN ISO 24343-1	≤ 0.05 mm	≤ 0.05 mm
Furniture leg	EN 424	No damage	No damage
Castor chair	EN ISO 4918	No damage	No damage
Curl resultant to heat	EN ISO 23999	≤ 2 mm	≤ 2 mm
Underfloor heating	EN ISO 10456	Suitable – max. 27°C	Suitable – max. 27°C
Thermal resistance	ISO 10456	0.03 m ² K/W	0.03 m ² K/W
Impact sound reduction	EN ISO EN 717-2	ΔL _w = 2 dB	ΔL _w = 2 dB
Reduction of in room impact noise	NF EN ISO 31-074	Class C (L _{n,e,w} < 85dB)	Class C (L _{n,e,w} < 85dB)
Light fastness	EN ISO 105-B02	≥ 6	≥ 6
Resistance to chemicals	EN ISO 26987	High resistance	High resistance
Slip resistance	EN 13893 DIN 51130	μ ≥ 0.30 R9 - Decosteel R10 - Neutral / Scandinavian / Luxury	μ ≥ 0.30 R9 - Decosteel R10 - Neutral / Scandinavian / Luxury
Electrical properties	EN 1015 EN 1081	≤ 2kV on concrete > 10 ⁹ Ω	≤ 2kV on concrete > 10 ⁹ Ω
Adhesion wear layer	EN 431	≥ 50N / 50mm	≥ 50N / 50mm
Colours		14	14

Technical data in force upon the date of publication (11/15). The values correspond to laboratory tests (no in situ test) and are subject to modification. Tarkett's instructions regarding installation, cleaning and maintenance shall be observed. Please contact your local sales rep. for these instructions.

CUSTOMS TARIFF: 48205000000F

Our Sustainability tag explains the content of our products and how they contribute to our sustainability strategy and human well-being.

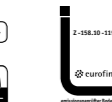
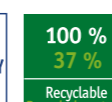



iD Inspiration **LOOSE-LAY**

Take a look at iD Inspiration Loose-lay collection with its unique herringbone anti-skid technology that provides stronger plank adherence and stability than other modular vinyl solutions. It also lets you mix and match from a wealth of great designs.



iD Inspiration LOOSE-LAY

Mix and match designs to create your own effect.
Take a look at what we imagined.

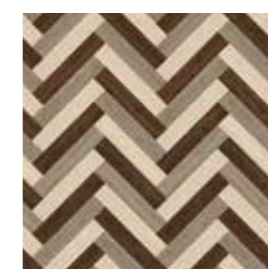

HYBRID HERRINGBONE

3 colours - Buy 1/3 of each colour*

Uses models:

Limed Oak - Beige (24640 000)

Limed Oak - Grey (24640 001)

Limed Oak - Brown (24640 002)

Plank format (cm): 22.9 x 121.9



GRAPHIC HERRINGBONE

3 colours - Buy 2/4 of Beige,
1/4 of Grey, 1/4 of Brown*

Uses models:

Limed Oak - Beige (24640 000)

Limed Oak - Grey (24640 001)

Limed Oak - Brown (24640 002)

Plank format (cm): 22.9 x 121.9



DUAL HERRINGBONE

2 colours - Buy 1/2 of each colour*

Uses models:

Limed Oak - Beige (24640 000)

Limed Oak - Grey (24640 001)

Plank format (cm): 22.9 x 121.9



GRADIENT HERRINGBONE

2 colours - Buy of 1/3 Beige, 2/3 of Brown*

Uses models:

Limed Oak - Beige (24640 000)

Limed Oak - Brown (24640 002)

Plank format (cm): 22.9 x 121.9



iD Inspiration LOOSE-LAY

Mix and match designs to create your own effect.
Take a look at what we imagined.



MIXED PATH

3 colours: Buy 1/3 of each colour*

Uses models:

Béton - White (24641 000)
Béton - Grey (24641 002)
Béton - Black (24641 001)

Tile format (cm): 30.5 x 61



MARBLE PATH

2 colours: Buy 1/2 of each colour*

Uses models:

Béton - White (24641 000)
Béton - Grey (24641 002)

Tile format (cm): 30.5 x 61



RAILWAY TRACK

4 colours: Buy 1/4 of each colour*

Uses models:

Béton - White (24641 000)
Béton - Grey (24641 002)
Béton - Black (24641 001)
Delicate wood - Black (24640 013)

Tile format (cm): 30.5 x 61
Plank format (cm): 22.9 x 121.9



GARDEN ALLEY

2 colours: Buy 1/5 of Wood, 4/5 of Béton*

Uses models:

Delicate wood - White (24640 011)
Béton - Grey (24641 002)

Tile format (cm): 30.5 x 61
Plank format (cm): 22.9 x 121.9

* Estimation based on this scaled square pattern



iD Inspiration LOOSE-LAY

Mix and match designs to create your own effect.
Take a look at what we imagined.



SLAM BEAT

2 colours - Buy 2/3 of Grey, 1/3 of Beige*

Uses model:

Beach Wood - Beige (24640 009)
Beach Wood - Grey (24640 010)

Plank format (cm): 22.9 x 121.9



TUNING FORK

2 colours - Buy 1/2 of each colour*

Uses model:

Beach Wood - Beige (24640 009)
Beach Wood - Grey (24640 010)

Plank format (cm): 22.9 x 121.9



TWO-STEP

2 colours - Buy 1/2 of each colour*

Uses model:

Beach Wood - Beige (24640 009)
Beach Wood - Grey (24640 010)

Plank format (cm): 22.9 x 121.9



WAVE REPEAT

2 colours - Buy 1/2 of each colour*

Uses model:

Beach Wood - Beige (24640 009)
Beach Wood - Grey (24640 010)

Plank format (cm): 22.9 x 121.9

* Estimation based on this scaled square pattern



iD Inspiration LOOSE-LAY

Mix and match designs to create your own effect.
Take a look at what we imagined.



TRENDY PALLET

3 colours - Buy 2/4 of Brown,
1/4 of Dark Brown, 1/4 of Grey*

Uses models:

Sawn Oak - Grey (24640 016)
Sawn Oak - Brown (24640 017)
Sawn Oak - Dark Brown (24640 018)

Plank format (cm): 22.9 x 121.9



TRENDY SQUARE

3 colours - Buy 2/4 of Dark Brown,
1/4 of Brown, 1/4 of Grey*

Uses models:

Sawn Oak - Grey (24640 016)
Sawn Oak - Brown (24640 017)
Sawn Oak - Dark Brown (24640 018)

Plank format (cm): 22.9 x 121.9



TRENDY LINE

2 colours - Buy 1/2 of each colour *

Uses models:

Sawn Oak - Grey (24640 016)
Sawn Oak - Brown (24640 017)

Plank format (cm): 22.9 x 121.9



TRENDY CHECKERBOARD

2 colours - Buy 1/2 of each colour *

Uses models:

Sawn Oak - Grey (24640 016)
Sawn Oak - Brown (24640 017)

Plank format (cm): 22.9 x 121.9

PLANK



LIMED OAK - BEIGE
24640000
LRV: 48.94% 22.9 x 121.9 cm



LIMED OAK - GREY
24640 001
LRV: 24.27% 22.9 x 121.9 cm



LIMED OAK - BROWN
24640 002
LRV: 6.46% 22.9 x 121.9 cm



MOUNTAIN OAK - NATURAL
24640 003
LRV: 21.59% 22.9 x 121.9 cm



MOUNTAIN OAK - BROWN
24640 004
LRV: 15.63% 22.9 x 121.9 cm



MOUNTAIN OAK - BLACK
24640 005
LRV: 5.27% 22.9 x 121.9 cm



CHRISTMAS PINE - WHITE
24640 006
LRV: 53.13% 22.9 x 121.9 cm



CHRISTMAS PINE - NATURAL
24640 007
LRV: 20.72% 22.9 x 121.9 cm



CHRISTMAS PINE - BROWN
24640 008
LRV: 15.65% 22.9 x 121.9 cm



BEACH WOOD - BEIGE
24640 009
LRV: 35.56% 22.9 x 121.9 cm



BEACH WOOD - GREY
24640 010
LRV: 35.68% 22.9 x 121.9 cm



DELICATE WOOD - WHITE
24640 011
LRV: 59.39% 22.9 x 121.9 cm



DELICATE WOOD - GREGE
24640 012
LRV: 23.25% 22.9 x 121.9 cm



DELICATE WOOD - BLACK
24640 013
LRV: 7.03% 22.9 x 121.9 cm



ELEGANT OAK - BEIGE
24640 014
LRV: 31.47% 22.9 x 121.9 cm



ELEGANT OAK - NATURAL
24640 015
LRV: 24.33% 22.9 x 121.9 cm



SAWN OAK - GREY
24640 016
LRV: 17.99% 22.9 x 121.9 cm



SAWN OAK - BROWN
24640 017
LRV: 17.13% 22.9 x 121.9 cm



SAWN OAK - DARK BROWN
24640 018
LRV: 9.94% 22.9 x 121.9 cm

TILE

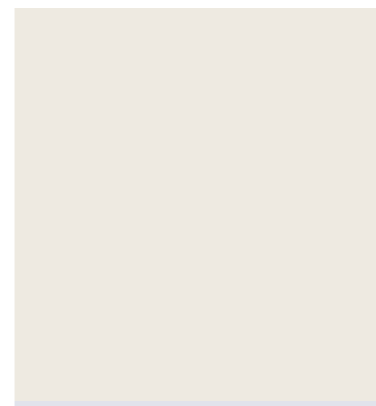

BÉTON - WHITE
24641 000
LRV: 63.1% 30.5 x 61 cm



BÉTON - GREY
24641 002
LRV: 17.54% 30.5 x 61 cm



BÉTON - BLACK
24641 001
LRV: 4.86% 30.5 x 61 cm

iD Inspiration LOOSE-LAY

iD Inspiration Loose-lay is up to three times faster to install than other modular vinyl solutions⁽¹⁾, making it ideal for small or occupied surfaces, or environments requiring fast installation. It even makes overnight renovation possible. It requires no or little subfloor preparation, as it absorbs uneven patches, and no glue⁽²⁾ for installation. Material and labour costs are therefore reduced. iD Inspiration Loose-lay's anti-skid backing is unique. Its patented herringbone design and pattern ensures strong plank adherence and stability.



A UNIQUE LAYING TECHNOLOGY FOR FAST AND COST-SAVING INSTALLATIONS

- 2.5 times higher adherence than its competitors⁽³⁾.
- Totally dimensionally stable, and as durable and reliable as a glue-down flooring.
- Easily removable with no damage to the product or the subfloor.

A WIDE SELECTION OF EXCLUSIVE AND ULTRA-REALISTIC DESIGNS

- 22 refined designs in plank (19 wood essences) and tile (3 stone patterns) formats.
- Coordinated with Tarkett accessories: skirtings, transitions and profiles.

GREAT RESISTANCE AND LOW MAINTENANCE

- Treated with the Tarkett unique TopClean XP™ polyurethane coating for greater resistance, quicker and more cost-effective cleaning and a better life-cycle cost.

A PEOPLE-FRIENDLY SOLUTION

- 100% recyclable.
- Contributes to improved indoor air quality with total VOC emissions at least 10 times lower than Europe's strictest standards.
- Uses a phthalate-free technology, based on alternative plasticizers that can be used for sensitive applications such as the production of toys, food packaging and medical devices.

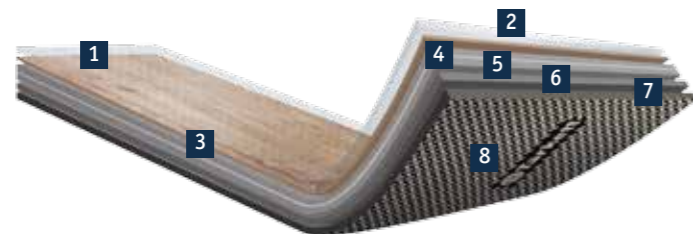

1. TopClean XP™ PUR reinforcement
for extreme resistance and easy low cost maintenance

2. Wear layer
0.55 mm for commercial traffic resistance

3. Printed film
in 22 different wood and stone designs

4. Core layer
for proper resistance to indentation

5. Glass fiber reinforcement
for perfect dimensional stability

6. Bottom layer
for a solid basis to the product

7. Balancing layer
for a curl-free product

8. Tarkett exclusive herringbone anti-skid backing
for exceptional adherence to the subfloor and skid resistance in all directions

(1) and (3) Estimation based on Tarkett's internal tests

(2) No acrylic adhesive needed, only a tackifier for very large areas. Please refer to installation instructions.



Accessories

Skirting



PVC DECORATIVE SKIRTINGS

Compact PVC skirting foreseen with decorative film and PUR treatment. To be glued. See skirting chart below for matching sku numbers.

Design & Colours	PVC decorative Skirting	Design & Colours	PVC decorative Skirting
LIMED OAK - BEIGE	26640 250	DELICATE WOOD - WHITE	26640 258
LIMED OAK - GREY	26640 251	DELICATE WOOD - GREGE	26640 260
LIMED OAK - BROWN	26640 252	DELICATE WOOD - BLACK	26640 259
MOUNTAIN OAK - NATURAL	26640 249	SAWN OAK - GREY	26640 255
MOUNTAIN OAK - BROWN	26640 248	SAWN OAK - BROWN	26640 256
MOUNTAIN OAK - BLACK	26640 247	SAWN OAK - DARK BROWN	26640 257
CHRISTMAS PINE - BROWN	26640 244	ELEGANT OAK - BEIGE	26640 243
CHRISTMAS PINE - WHITE	26640 246	ELEGANT OAK - NATURAL	26640 242
CHRISTMAS PINE - NATURAL	26640 245	BÉTON - WHITE	26640 240
BEACH WOOD - BEIGE	26640 253	BÉTON - GREY	26640 239
BEACH WOOD - GREY	26640 254	BÉTON - BLACK	26640 241

Profile

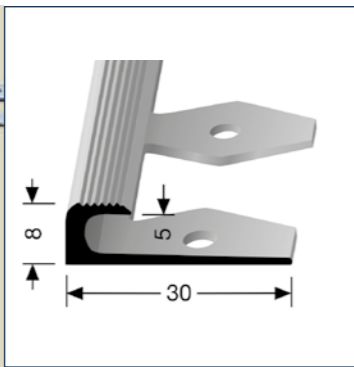

FLEXIBLE PROFILE

Aluminium stop profile, to be screwed.

2 colours: Ref.: Silver 1456 011
 Ref.: Stainless Steel 1456 012

Delivery form: 10 units of 2.5 lm

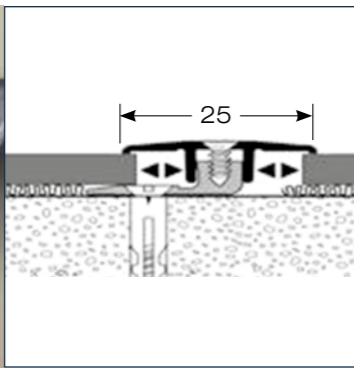
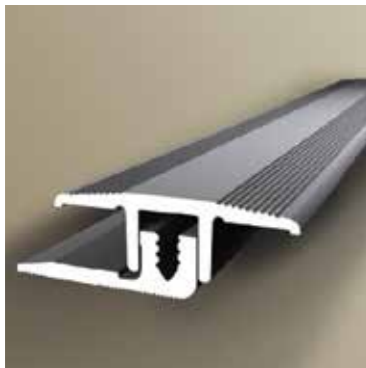

TRANSITION PROFILE

Aluminium transition profile, to be screwed.

2 colours: Ref.: Silver 1456 011
 Ref.: Stainless Steel 1456 012

Delivery form: 10 units of 2.7 lm

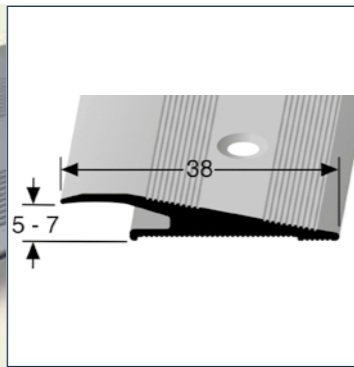
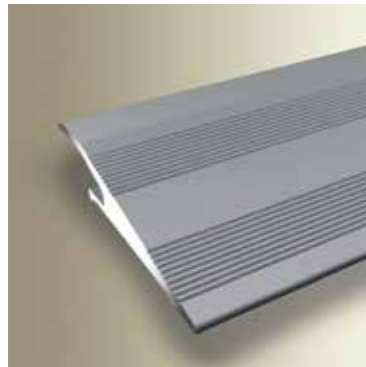

RAMP PROFILE

Aluminium ramp profile, to be screwed.

2 colours: Ref.: Silver 1456 011
 Ref.: Stainless Steel 1456 012

Delivery form: 10 units of 2.7 lm

Specification

Modular vinyl floor covering, with glass fibre reinforcement. TopClean XP™ polyurethane reinforcement. In plank and tile format. Product standard: EN ISO 10582.

CERTIFICATION & CLASSIFICATION	STANDARDS	iD Inspiration Loose-lay
Type of floor covering	EN ISO 10582	Compact resilient floor covering
CE certification	EN 14041	Yes
Classification	EN ISO 10874	Commercial: 33 Industrial: 42
TECHNICAL CHARACTERISTICS	STANDARDS	iD Inspiration Loose-lay
Total thickness	EN ISO 24346	4.5 mm
Wear layer thickness	EN ISO 24340	0.55 mm
Surface treatment (PUR)		Yes
Bevelled edges		No
Total weight	EN ISO 23997	7500 g/m ²
Wear layer binder content	ISO 10582	Type I
Form of delivery	EN ISO 24342 Planks	22.9 x 121.9 cm 10 planks/box (= 2.79 m ² - 20.9 kg) 52 boxes/pallet (= 145.16 m ² - 1088.7 kg)
	Tiles	30.5 x 61 cm 14 tiles/box (= 2.6 m ² - 19.5 kg) 54 boxes/pallet (= 140.65 m ² - 1054.9 kg)

TECHNICAL PERFORMANCES	STANDARDS	iD Inspiration Loose-lay
Dimensional stability	EN ISO 23999	≤ 0.10 %
Reaction to fire	EN 13501-1	B _{f1} s1
Residual indentation	EN ISO 24343-1	≤ 0.10 mm
Furniture leg	EN 424	No damage
Castor chair	EN ISO 4918	No damage
Thermal resistance	ISO 10456	0.04 m ² K/W
Impact sound reduction	EN ISO 717-2	8 dB
Light fastness	EN ISO 105-B02	≥ 6
Resistance to chemicals	EN ISO 26987	High resistance
Slip resistance	EN 13893 DIN 51130	μ ≥ 0.30 DS R9
Electrical properties	EN 1081	ca. 10 ¹¹ Ohm
Colours		22

Technical data in force upon the date of publication (11/15). The values correspond to laboratory tests (no in situ test) and are subject to modification. Tarkett's instructions regarding installation, cleaning and maintenance shall be observed. Please contact your local sales rep. for these instructions.

CUSTOMS TARIFF: 482050000000F

Our Sustainability tag explains the content of our products and how they contribute to our sustainability strategy and human well-being.

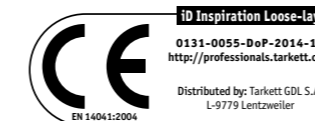

iD Square

Encourage efficiency at work by promoting one perfect team: comfort & well-being. For a calm and collaborative setting or a dynamic and inspiring space, you can find what you're looking for with the new iD Square collection.

SKY IS THE LIMIT



iD Square

Endless possibilities to create the ideal office environment.
See what design layouts we've been working on.



LINEAR TWIST

3 colours - Buy 1/4 of Natural, 1/4 of Grey and 2/4 of Blue*

Uses models:

Minimal Wood - Natural (24563 100)
Minimal Wood - Grey (24563 101)
Dashes - Blue (24562 100)

Plank format (cm): 25 x 100
Tile format (cm): 50 x 50



BREADCRUMBS

3 colours - Buy 2/4 of Natural, 1/4 of Grey and 1/4 of Blue*

Uses models:

Minimal Wood - Natural (24563 100)
Minimal Wood - Grey (24563 101)
Dashes - Blue (24562 100)

Plank format (cm): 25 x 100
Tile format (cm): 50 x 50

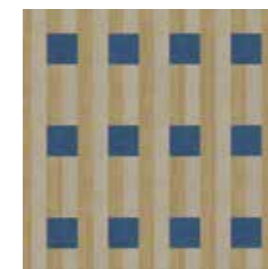

TWISTED WEAVE

3 colours - Buy 2/5 of Natural, 2/5 of Grey and 1/5 of Blue*

Uses models:

Minimal Wood - Natural (24563 100)
Minimal Wood - Grey (24563 101)
Dashes - Blue (24562 100)

Plank format (cm): 25 x 100
Tile format (cm): 50 x 50



BOLIVIAN BASKET

3 colours - Buy 4/9 of Natural, 4/9 of Grey and 1/9 of Blue*

Uses models:

Minimal Wood - Natural (24563 100)
Minimal Wood - Grey (24563 101)
Dashes - Blue (24562 100)

Plank format (cm): 25 x 100
Tile format (cm): 50 x 50

* Estimation based on this scaled square pattern



iD Square

Endless possibilities to create the ideal office environment.
See what design layouts we've been working on.



BISHOP MOVES

3 colours - Buy 1/3 of each color*

Uses models:

- Vintage Zinc - Beige (24565 001)
- Vintage Zinc - Grege (24565 003)
- Vintage Zinc - Light Copper (24565 004)

Tile format (cm): 66 x 66



CUBE 2

3 colours - Buy 4/9 of Beige, 4/9 of Grege and 1/9 of Light Copper*

Uses models:

- Vintage Zinc - Beige (24565 001)
- Vintage Zinc - Grege (24565 003)
- Vintage Zinc - Light Copper (24565 004)

Tile format (cm): 66 x 66



NAPOLITAN

3 colours - Buy 1/3 of each colour *

Uses models:

- Vintage Zinc - Beige (24565 001)
- Vintage Zinc - Grege (24565 003)
- Vintage Zinc - Light Copper (24565 004)

Tile format (cm): 66 x 66



FLAG

3 colours - Buy 1/3 of each colour *

Uses models:

- Vintage Zinc - Beige (24565 001)
- Vintage Zinc - Grege (24565 003)
- Vintage Zinc - Light Copper (24565 004)

Tile format (cm): 66 x 66

* Estimation based on this scaled square pattern

LARGE TILE



VINTAGE ZINC - METALLIC
24565 002
LRV: 27.78% 66 x 66 cm



VINTAGE ZINC - BEIGE
24565 001
LRV: 24.66% 66 x 66 cm



VINTAGE ZINC - DARK GREY
24565 000
LRV: 18.78% 66 x 66 cm



VINTAGE ZINC - GREGE
24565 003
LRV: 10.28% 66 x 66 cm



VINTAGE ZINC - LIGHT COPPER
24565 004
LRV: 19.73% 66 x 66 cm



GRID - METALLIC
24566 000
LRV: 30.77% 66 x 66 cm

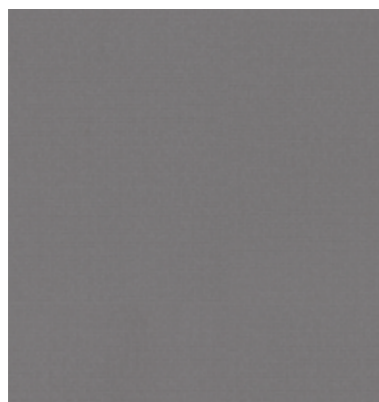

GRID - GREY
24566 003
LRV: 20.36% 66 x 66 cm

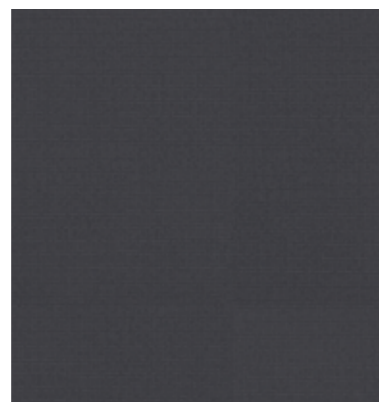

GRID - BLACK
24566 002
LRV: 8.3% 66 x 66 cm



GRID - METALLIC BLUE
24566 001
LRV: 24.47% 66 x 66 cm

TILE



TISSE - LIGHT GREY
24560 035
LRV: 35.46% 50 x 50 cm



TISSE - CHOCOLATE
24560 033
LRV: 18.65% 50 x 50 cm

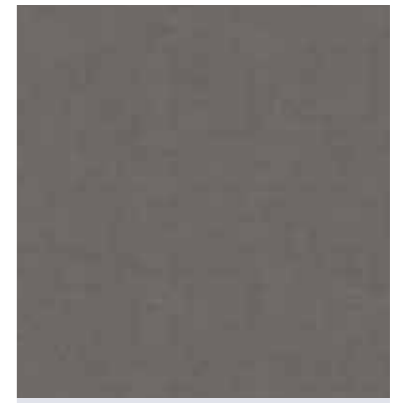

TISSE - DARK GREY
24560 032
LRV: 14.57% 50 x 50 cm



FABRICS - LIGHT GREY
24562 001
LRV: 33.47% 50 x 50 cm



FABRICS - GREGE
24562 000
LRV: 10.21% 50 x 50 cm



FABRICS - GREY
24562 002
LRV: 26.64% 50 x 50 cm



PATCHWORK - LIGHT GREY
24560 026
LRV: 30.67% 50 x 50 cm



PATCHWORK - ANTHRACITE
24560 024
LRV: 13.54% 50 x 50 cm



ZEN - GREY
24560 022
LRV: 15.17% 50 x 50 cm

TILE



ZEN - BROWN

24560 014
LRV: 20.9% 50 x 50 cm



PATINE - GRIS

24564 002
LRV: 24.65% 50 x 50 cm



PATINE - LIGHT CHOCOLATE

24564 040
LRV: 28.89% 50 x 50 cm



DASHES - GREY

24562 101
LRV: 17.39% 50 x 50 cm



DASHES - GREEN

24562 104
LRV: 14.95% 50 x 50 cm



DASHES - PURPLE

24562 103
LRV: 16.38% 50 x 50 cm



PATINE - ANTHRACITE

24564 044
LRV: 16.1% 50 x 50 cm

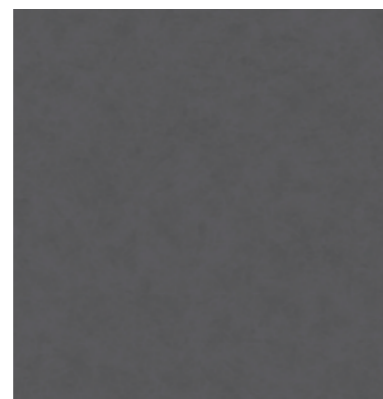

PATINE - DARK ANTHRACITE

24564 046
LRV: 9.79% 50 x 50 cm



PATINE - CHOCOLATE

24564 042
LRV: 12.24% 50 x 50 cm



DASHES - BLUE

24562 100
LRV: 11.06% 50 x 50 cm



PATCHWOOD - WHITE

24563 200
LRV: 35.95% 50 x 50 cm



PATCHWOOD - GREY

24563 201
LRV: 22.16% 50 x 50 cm



PATINE - RED

24564 048
LRV: 28.98% 50 x 50 cm

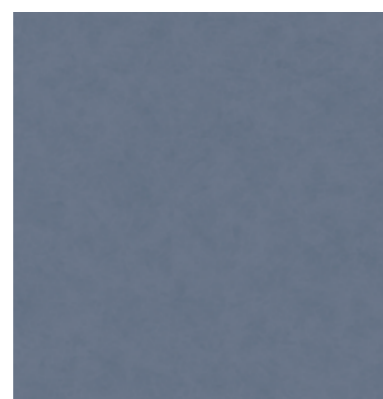

PATINE - BLUE

24564 045
LRV: 13.94% 50 x 50 cm



DASHES - LIGHT GREY

24562 102
LRV: 30.4% 50 x 50 cm

PLANK & TILE



PLATEAU ASH - GREY

24563 009 25 x 100 cm
24567 009 50 x 50 cm
LRV: 22.71%



MINIMAL WOOD - GREY

24563 101 25 x 100 cm
24567 101 50 x 50 cm
LRV: 21.97%



MINIMAL WOOD - DARK GREY

24563 102 25 x 100 cm
24567 102 50 x 50 cm
LRV: 18.26%



MINIMAL WOOD - NATURAL

24563 100 25 x 100 cm
24567 100 50 x 50 cm
LRV: 19.1%



BOX

iD Square

iD Square has the largest variety of designs & colours on the market to create serene or more stimulating ambiances to reflect the image and values of your company. Its colours combine and coordinate to enhance zoning. This unique offer has 3 different formats: 50 x 50 cm for classic & timeless designs, 66 x 66 cm with modern designs and fewer joints for optimal aesthetic, 25 x 100 cm and 50 x 50 cm to play on multi-combinations.

EMPLOYEES COMFORT & WORK EFFECTIVENESS

- Better in-room acoustic with less sound transmission - ideal for working areas where concentration is needed.
- Unmatched indoor air quality with <math><10\mu\text{g}/\text{m}^3</math> emission
- Phthalate-free technology is a guaranteed standard to ensure your employees' health.

EASY AND QUICK TO INSTALL & REMOVE

- Tackified offer: the flooring is easier to install and remove to ensure a tile replacement or to reach the subfloor.
- Smaller, more manageable pack quantities to minimise wastage on site.
- New 66 x 66 cm format that allows a 10% faster installation.

GREAT RESISTANCE AND EASY CLEANING

- Specifically developed for the demanding heavy-traffic work environment.
- Resistant to spread of water & coffee stains and easy to keep clean.
- Hygienic surface treated with TopClean XP™ that hardens the surface, simplifies cleaning and maintenance through reduced use of water, energy and chemical detergents.

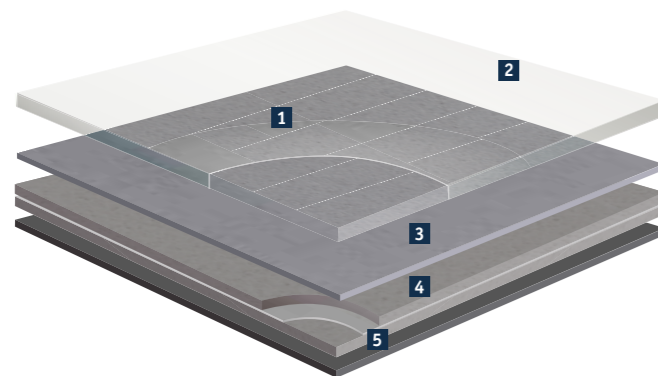

1. TopClean XP™ PUR reinforcement
Extreme resistance and easy low cost maintenance

2. 0.80mm pure PVC transparent wear layer
Resistance to wear

3. Decorated compact impregnation
37 design options

4. Structure built with solid homogeneous calandered layers reinforced with non-woven glass fibre
Exceptional dimensional stability and excellent resistance to tear and indentation

5. Chemical foam backing
Acoustic performances





Accessories

Skirting



WALL BASE DECORATIVE SET-ON SKIRTING

Compact PVC skirting foreseen with decorative film and PUR treatment. To be glued.

2 colours:  Ref.: White 26640 500
 Ref.: Aluminium 26640 501
 Delivery Form: 16 units of 2.5 lm

Profile



FLEXIBLE PROFILE

Aluminium stop profile, to be screwed. Available in Silver (1456 011) and Stainless Steel (1456 012) finishes.

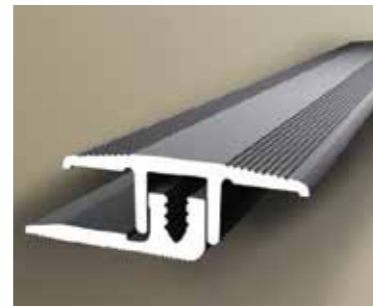

TRANSITION PROFILE

Aluminum transition profile, to be screwed. Available in Silver (1451 011) and Stainless Steel (1451 012) finishes.

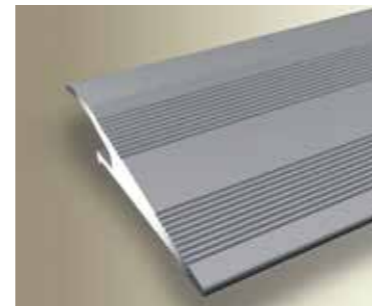

RAMP PROFILE

Aluminium ramp profile, to be screwed. Available in Silver (1456 011) and Stainless Steel (1456 012) finishes.

Accessibility



WARNING TILE

Helps recognize a change in level, in accordance with regulatory requirements for disabled access and safety. Various formats available. Self-adhesive or to be glued to the floorcovering (according to product).

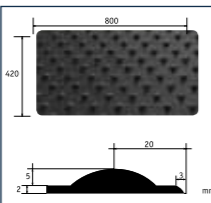

Self-adhesive rectangular tiles
 Format: 815 x 420 x 8mm
 Ordering unit: 1 box of 6 tiles

Self-adhesive square tiles
 Format: 450 x 420 x 8mm
 Ordering unit: 1 box of 20 tiles

	Self-adhesive	
	Rectangular tile	Square tile
White	1440 350	1440 450
Grey	1440 351	1440 451
Black	1440 352	1440 452
Ivory	1440 353	1440 453
Red	1440 354	1440 454
Yellow	1440 355	1440 455



3D STUD

Ready-to-use podotactile studs to be simply fitted on top of the existing floorcovering.

Format (stud): 5 x 25mm
 Ordering unit: 1 box of 200 studs

	Self-adhesive
White	1440 050
Grey	1440 051
Black	1440 052
Ivory	1440 053
Red	1440 054
Yellow	1440 055

Specification

Loose lay printed acoustic floorcovering in tile format.
 Glass fibre reinforcement. TopClean XP™ Polyurethane reinforcement on surface.

CERTIFICATION & CLASSIFICATION	STANDARDS	iD Square
Floor covering classification	EN ISO 10874	Acoustic resilient floor covering Commercial very heavy: 34
CE certification	EN 14041	Yes
TECHNICAL CHARACTERISTICS	STANDARDS	iD Square
Total thickness	EN ISO 24346	4.5 mm
Wear layer thickness	EN ISO 24340	0.80 mm
Total weight	EN ISO 23997	5195 g/m ²
Wear layer binder content	ISO 10582	Type I
Form of delivery	EN ISO 24342	
	Planks	25 x 100 cm 9 planks/box (= 2.25 m ² - 12 kg) - 48 boxes/pallet
	Tiles	50 x 50 cm 9 tiles/box (= 2.25 m ² - 12 kg) - 48 boxes/pallet 66 x 66 cm 5 tiles/box (= 2.22 m ² - 12 kg) - 26 boxes/pallet
TECHNICAL PERFORMANCES	STANDARDS	iD Square
Dimensional stability	EN ISO 23999	≤ 0.10 %
Reaction to fire	EN 13501-1	B _n s1 loose-laid or glued over any A2 _n or A1 _n substrate (concrete) C _n s1 loose-laid or glued over any derivate wood substrate
Residual indentation	Average measured value EN ISO 24343-1 requirement	0.15 mm ≤ 0.20 mm
Furniture leg	EN 424	No damage
Castor chair	EN ISO 4918	No damage
Thermal resistance	ISO 10456	0.04 m ² K/W
Impact sound reduction	EN ISO 717-2	ΔL _w = 15 dB (±1 dB)
Reduction of in room impact noise	NF S 31-074	Class B - L _{n,e,w} = < 75 dB
Acoustical absorption	EN ISO 11654	α _W = 0.05
Light fastness	EN ISO 105-B02	≥ 6
Resistance to chemicals	EN ISO 26987	High resistance
Slip resistance	EN 13893 DIN 51130	μ ≥ 0.30 R9
Electrical properties	EN 1081	R _i > 10 ¹⁰ Ohm
Colours		41

Technical data in force upon the date of publication (11/15). The values correspond to laboratory tests (no in situ test) and are subject to modification. Tarkett's instructions regarding installation, cleaning and maintenance shall be observed. Please contact your local sales rep. for these instructions.

CUSTOMS TARIFF: 4820500000000

Our Sustainability tag explains the content of our products and how they contribute to our sustainability strategy and human well-being.



iD Tilt

Get tough with iD Tilt, the floor designed to meet your high traffic commercial and industrial needs. Even in heavy-traffic areas, flooring designs and layouts can enhance pathways or zoning and still be playful.

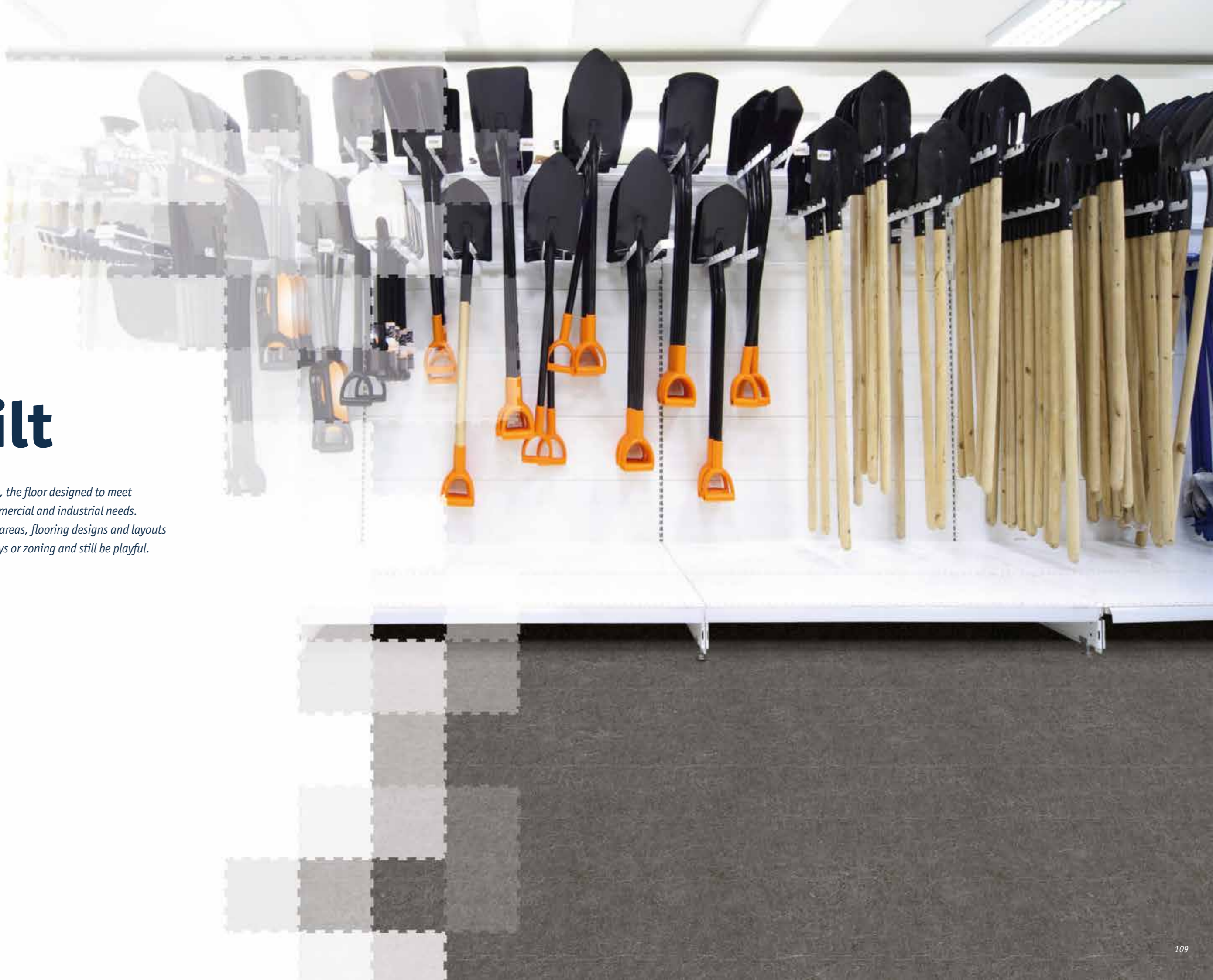

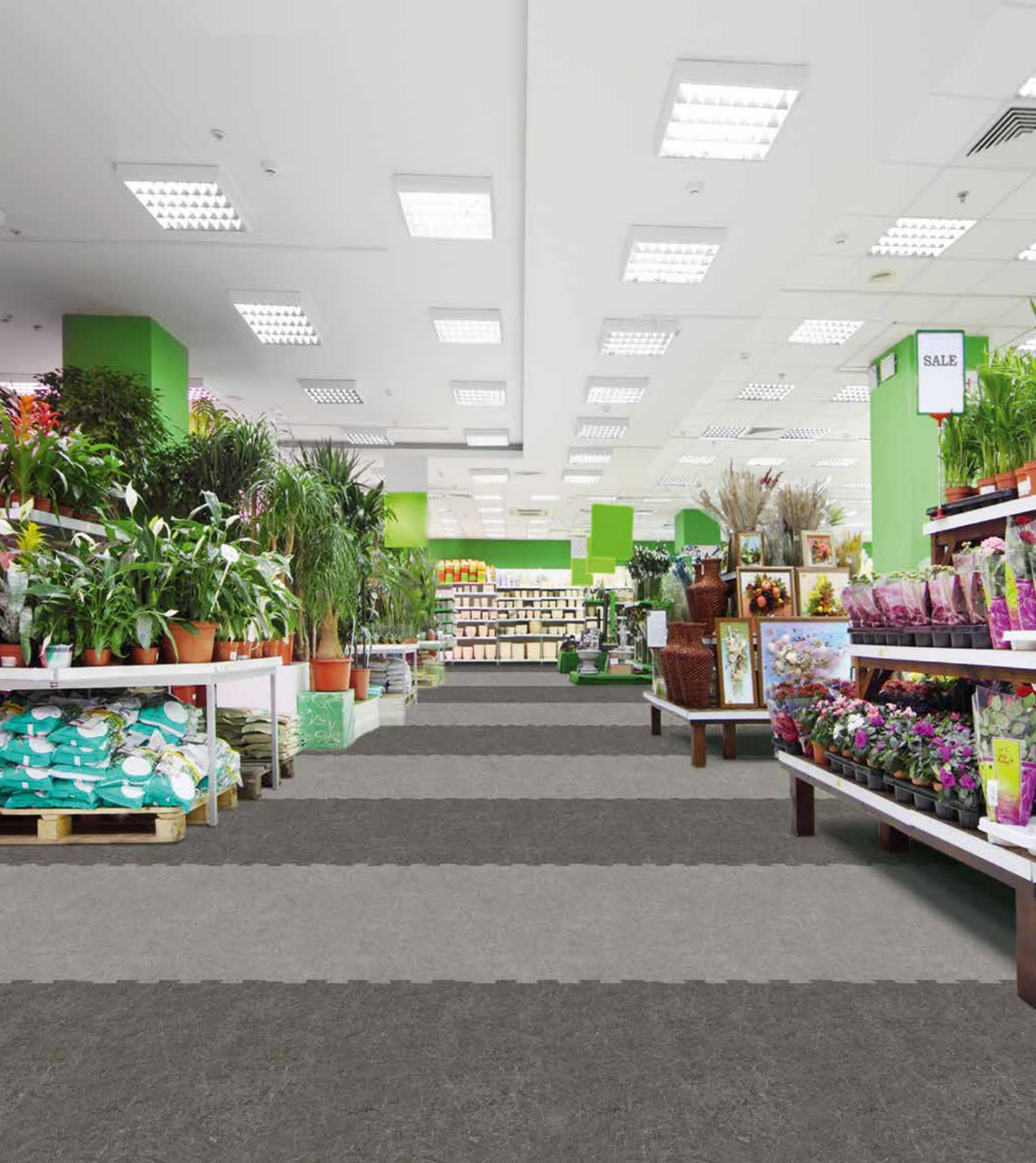

iD Tilt

Make distinctive design an easy order by playing with colours and layouts.



GIANT LINES

2 colours - Buy 1/2 of Grey, 1/2 of Dark Grey*

Uses models:
Concrete - Grey (001)
Concrete - Dark Grey (002)

Tile format (cm): 45.72 x 45.72



DASHES

3 colours - Buy 1/3 of each colour*

Uses models:
Concrete - Grey (001)
Concrete - Dark Grey (002)
Concrete - Beige (000)

Tile format (cm): 45.72 x 45.72



GRADIENT CODE

3 colours - Buy 2/5 of Grey, 1/5 of Dark Grey and 2/5 of Beige*

Uses models:
Concrete - Grey (001)
Concrete - Dark Grey (002)
Concrete - Beige (000)

Tile format (cm): 45.72 x 45.72



GRADIENT CODE 2

3 colours - Buy 1/4 of Grey, 2/4 of Dark Grey and 1/4 of Beige*

Uses models:
Concrete - Grey (001)
Concrete - Dark Grey (002)
Concrete - Beige (000)

Tile format (cm): 45.72 x 45.72

GRANITE



GRANITE - TRAFFIC RED RAL 3020

4697 006
91.44 x 91.44 cm

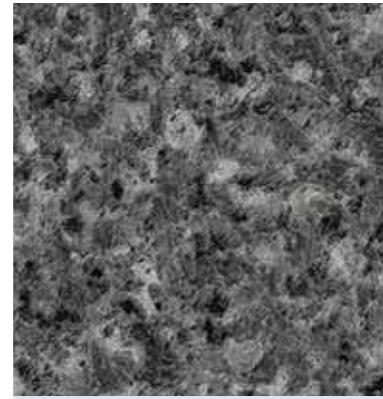

GRANITE - BLACK

4697 004
91.44 x 91.44 cm



GRANITE - TRAFFIC BLUE RAL 5017

4697 007
91.44 x 91.44 cm



GRANITE - GREY

4697 005
91.44 x 91.44 cm

CONCRETE



CONCRETE - DARK GREY

24750 002
45.72 x 45.72 cm



CONCRETE - GREY

24750 001
45.72 x 45.72 cm



CONCRETE - BEIGE

24750 000
45.72 x 45.72 cm

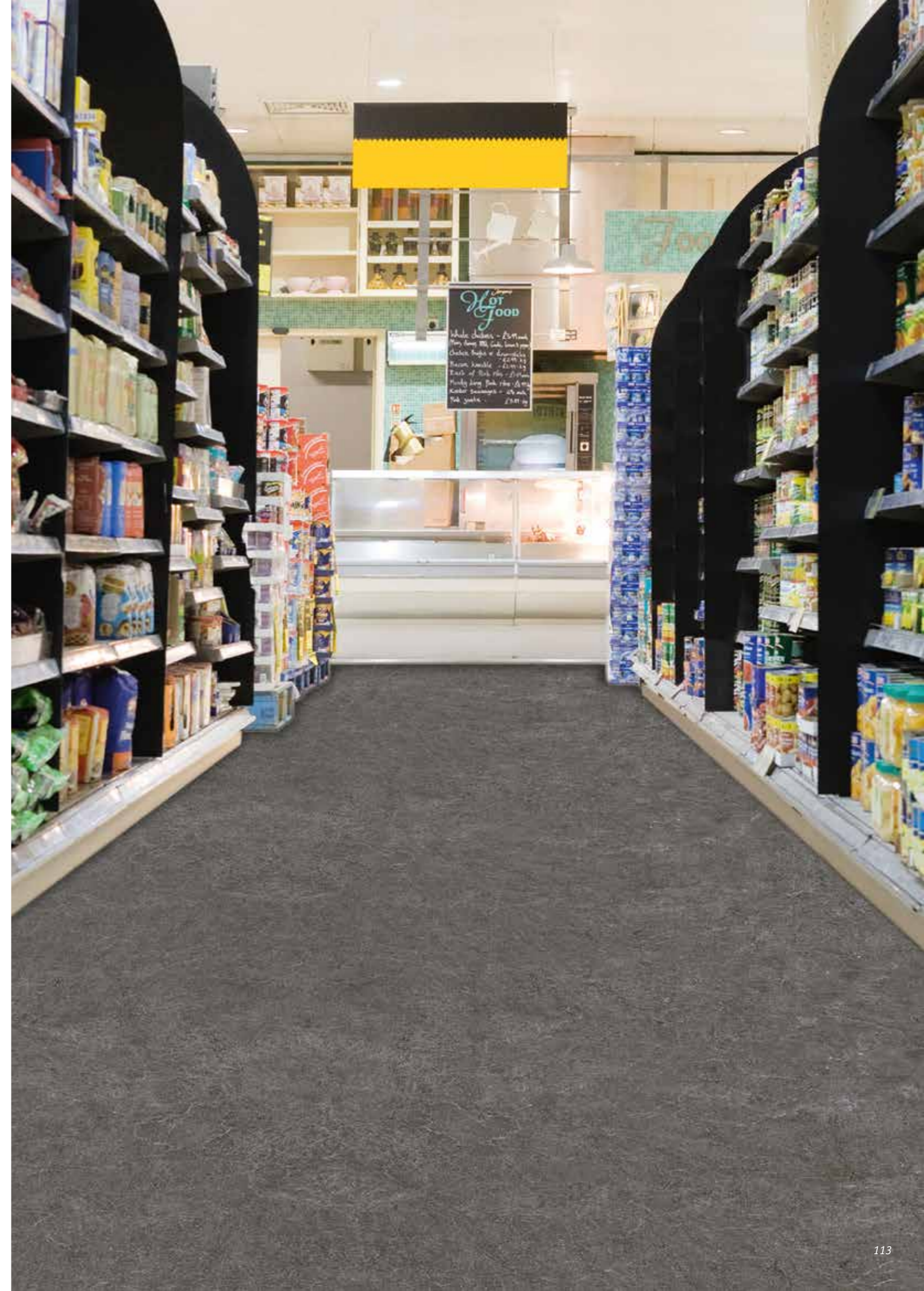

iD Tilt

iD TILT is Tarkett's floating floorcovering solution designed for commercial or industrial applications in both new builds and renovation projects. Easy to install, it keeps installation time to a minimum and iD TILT also reduces business losses due to construction downtime. Good value for your money, iD TILT saves you time and is an invaluable cost-saver on any construction project.

EASY TO INSTALL

- Limited subfloor preparation = time saved: 20% quicker than glue-down products
- No glue required = cost & time savings: 10% lower installation costs
- Your floor immediately available for use = no loss of business: overnight installation

EASY TO MAINTAIN

- Easy to remove & to renovate
- No damage to subfloor
- Easy to clean: TopClean XP™ surface treatment

HELPS DEFINE SPACES

- Create shop in shop corners and demo areas
- Directional signage
- Divide areas

A SOLID CONSTRUCTION

- Suitable for high traffic areas
- Very resistant interlocking system
- Clean appearance
- Long-lasting Performance

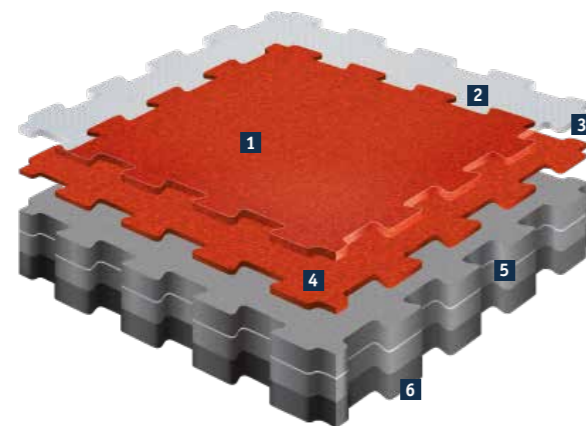

1. TopClean XP™ PUR reinforcement
extreme resistance and easy low cost maintenance

2. Surface embossing
for better non slip properties

3. Pure PVC transparent wear layer
Exceptionally hard wearing and indentation resistant

4. Design film
7 design options

5. Core layer with glass fiber reinforcement
excellent dimensional stability and resistance to tear and indentation

6. Balancing layer
for a curl-free product

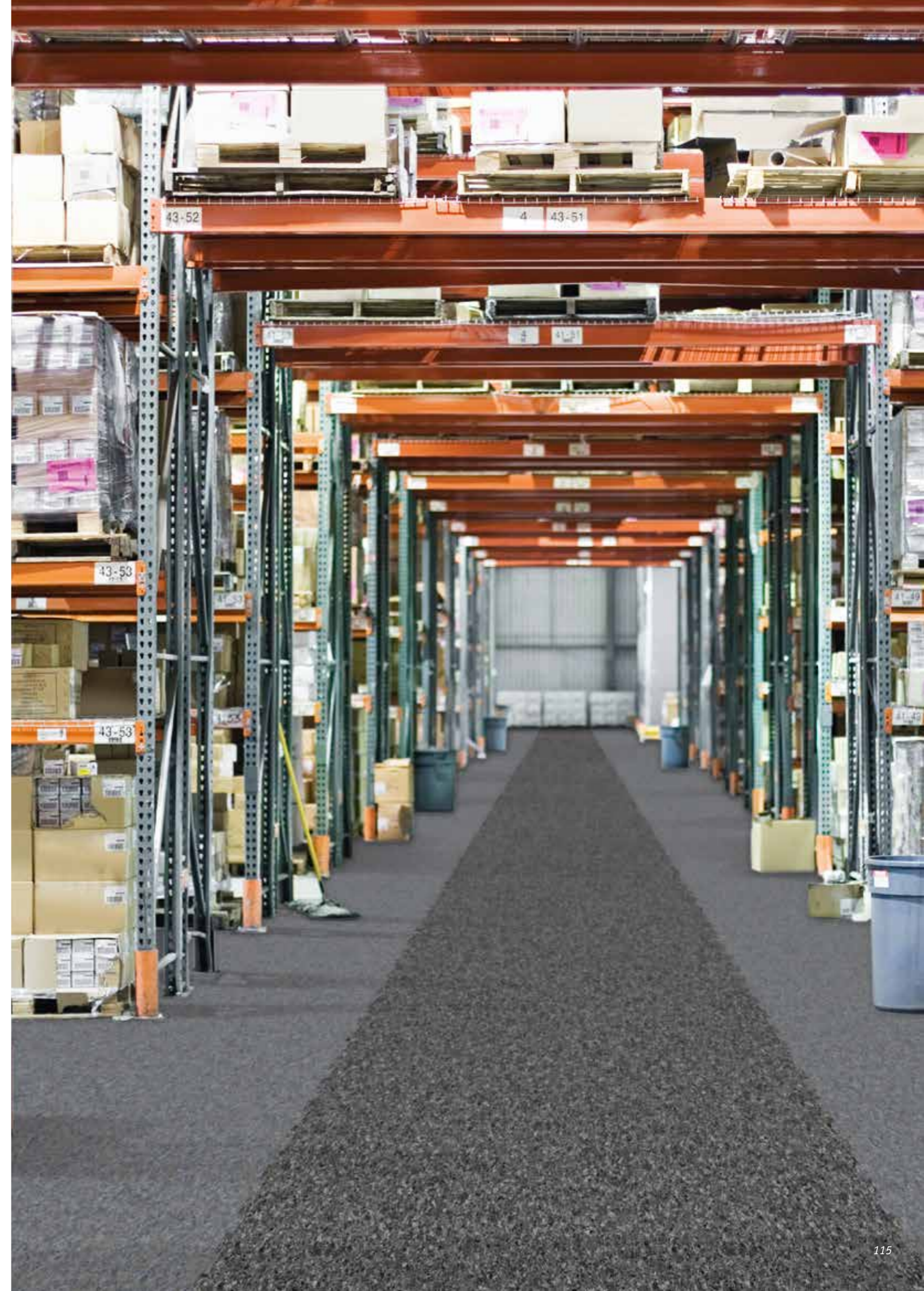



Accessories

Skirting



WALL BASE DECORATIVE SET-ON SKIRTING

Compact PVC skirting foreseen with decorative film and PUR treatment. To be glued.

2 colours:  Ref.: White 26640 500
 Ref.: Aluminium 26640 501
 Delivery Form: 16 units of 2.5 lm

Profile



FLEXIBLE PROFILE

Aluminium stop profile, to be screwed. Available in Silver (1456 011) and Stainless Steel (1456 012) finishes.

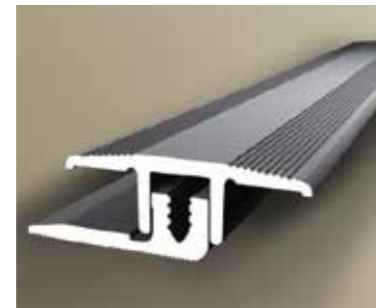

TRANSITION PROFILE

Aluminum transition profile, to be screwed. Available in Silver (1451 011) and Stainless Steel (1451 012) finishes.

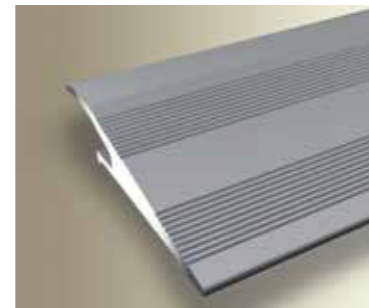

RAMP PROFILE

Aluminium ramp profile, to be screwed. Available in Silver (1456 011) and Stainless Steel (1456 012) finishes.

Accessibility



WARNING TILE

Helps recognize a change in level, in accordance with regulatory requirements for disabled access and safety. Various formats available. Self-adhesive or to be glued to the floorcovering (according to product).

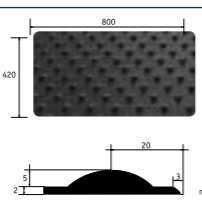

Self-adhesive rectangular tiles
Format: 815 x 420 x 8mm
Ordering unit: 1 box of 6 tiles

Self-adhesive square tiles
Format: 450 x 420 x 8mm
Ordering unit: 1 box of 20 tiles

	Self-adhesive	
	Rectangular tile	Square tile
White	1440 350	1440 450
Grey	1440 351	1440 451
Black	1440 352	1440 452
Ivory	1440 353	1440 453
Red	1440 354	1440 454
Yellow	1440 355	1440 455

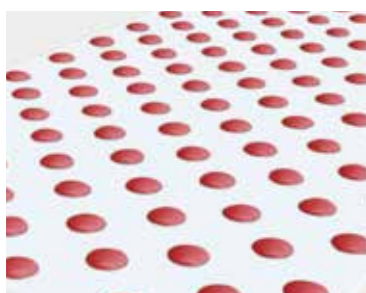

3D STUD

Ready-to-use podotactile studs to be simply fitted on top of the existing floorcovering.

Format (stud): 5 x 25mm
Ordering unit: 1 box of 200 studs

	Self-adhesive
White	1440 050
Grey	1440 051
Black	1440 052
Ivory	1440 053
Red	1440 054
Yellow	1440 055

Specification

Modular heterogeneous product with interlocking connection.
Product standard: ISO 10582.

CERTIFICATION & CLASSIFICATION	STANDARDS	Tilt
Type of floor covering	EN ISO 10582	Modular heterogeneous product with interlocking connection
CE certification	EN 14041	Yes
Classification	EN ISO 10874 - EN 685	Commercial: 34 Industrial: 43
TECHNICAL CHARACTERISTICS	STANDARDS	Tilt
Total thickness	EN ISO 24346 - EN 428	5.0 mm
Wear layer thickness	EN ISO 24340 - EN 429	0.70 mm
Surface treatment (PUR)		Yes
Total weight	EN ISO 23997 - EN 430	7400 g/m ²
Wear layer binder content	ISO 10582	Type I
Form of delivery	EN ISO 24342 - EN 427	
	Tiles	91.44 x 91.44 cm (Granite) 3 tiles/box (= 2.51 m ² - 20.10 kg) 45.72 x 45.72 cm (Concrete) 10 tiles/box (= 2.09 m ² - 16.70 kg)
TECHNICAL PERFORMANCES	STANDARDS	Tilt
Dimensional stability	EN ISO 23999 - EN 434	< 0.15 %
Reaction to fire	EN 13501-1	B _{fl} -s1 over concrete substrate
Residual indentation	EN ISO 24343-1 - EN 433	< 0.10 mm
Furniture leg	ISO 16581 - EN 424	No damage
Castor chair	ISO 4918 - EN 425	No damage
Curl resultant to heat	ISO 23999 - EN 434	≤ 2 mm
Thermal resistance	EN ISO 10456	approx. 0.05 m ² K/W
Impact sound reduction	EN ISO 717-2	ΔL _w = 6 dB
Light fastness	EN ISO 105-B02	≥ 6
Resistance to chemicals	EN ISO 26987 - EN 423	Resistance
Slip resistance	EN 13893 DIN 51130	μ ≥ 0.30 DS R9
Electrical properties	EN 1815 EN 1081	< 2 kV on concrete R1 > 109 Ω
Colours		Granit: 4 - Concrete: 3

Technical data in force upon the date of publication (11/15). The values correspond to laboratory tests (no in situ test) and are subject to modification. Tarkett's instructions regarding installation, cleaning and maintenance shall be observed. Please contact your local sales rep. for these instructions.

CUSTOMS TARIFF: 482050000000F

Our Sustainability tag explains the content of our products and how they contribute to our sustainability strategy and human well-being.

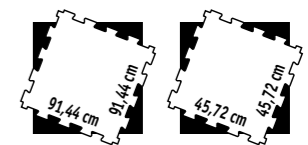

The 2 formats are not interconnectable

iD Essential Click

Express yourself through flooring design with 8 versatile and amazing colours from the iD Essential Click collection. You can also add a 19 dB impact sound reduction acoustic underlay for more at-home comfort.





iD Essential Click

Explore some of the combinations we've created to bring a new look and feel to your interior design.



BRITISH ALLEY

2 colours - Buy 1/6 of Dark Grey and 5/6 of Light Grey*

Uses models:

Toasted Oak - Light Grey (24722 003)
Toasted Oak - Dark Grey (24722 004)

Plank format (cm): 18.3 x 122



HEARTBEAT

2 colours - Buy 1/2 of each colour*

Uses models:

Toasted Oak - Light Grey (24722 003)
Toasted Oak - Dark Grey (24722 004)

Plank format (cm): 18.3 x 122

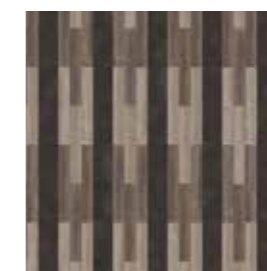

V BEAT

3 colours - Buy 1/3 of each colour*

Uses models:

Toasted Oak - Light Grey (24722 003)
Toasted Oak - Dark Grey (24722 004)
Rust Metal - Black (24723 002)

Plank format (cm): 18.3 x 122

Tile format (cm): 31 x 60.3

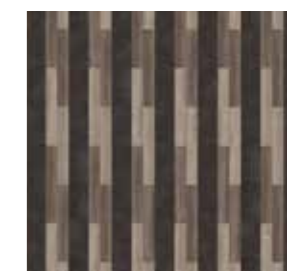

DISRUPTED BEAT

3 colours - Buy 1/3 of each colour*

Uses models:

Toasted Oak - Light Grey (24722 003)
Toasted Oak - Dark Grey (24722 004)
Rust Metal - Black (24723 002)

Plank format (cm): 18.3 x 122

Tile format (cm): 31 x 60.3

* Estimation based on this scaled square pattern

iD Essential Click

Explore some of the combinations we've created to bring a new look and feel to interior design.



FRENCH MARINIERE

2 colours - Buy 1/2 of each colour*

Uses models:
Limewashed Oak - Beige (24722 000)
Limewashed Oak - Brown (24722 001)

Plank format (cm): 18.3 x 122



CLUB TIE

2 colours - Buy 3/4 of Beige and 1/4 of Brown*

Uses models:
Limewashed Oak - Beige (24722 000)
Limewashed Oak - Brown (24722 001)

Plank format (cm): 18.3 x 122



LINEAR FIELD

3 colours - Buy 1/3 of each colour*

Uses models:
Limewashed Oak - Beige (24722 000)
Limewashed Oak - Brown (24722 001)
Rust Metal - Brown (24723 001)

Plank format (cm): 18.3 x 122
Tile format (cm): 31 x 60.3



LINEAR FIELD 2

3 colours - Buy 1/3 of each colour*

Uses models:
Limewashed Oak - Beige (24722 000)
Limewashed Oak - Brown (24722 001)
Rust Metal - Brown (24723 001)

Plank format (cm): 18.3 x 122
Tile format (cm): 31 x 60.3

* Estimation based on this scaled square pattern

iD Essential Click



LIMEWASHED OAK* - BEIGE
 24722 000
 18.3 x 122 cm
 LRV: 47.5%



LIMEWASHED OAK* - BROWN
 24722 001
 18.3 x 122 cm
 LRV: 20.7%



TOASTED OAK - LIGHT GREY
 24722 003
 18.3 x 122 cm
 LRV: 26.7%



TOASTED OAK - DARK GREY
 24722 004
 18.3 x 122 cm
 LRV: 16.5%



DELICATE OAK - NATURAL
 24722 002
 18.3 x 122 cm
 LRV: 17.3%



RUST METAL - BROWN
 24723 001
 31 x 60.3 cm
 LRV: 7.4%



RUST METAL - BLACK
 24723 002
 31 x 60.3 cm
 LRV: 4.8%



STONE - GREY
 24723 000
 31 x 60.3 cm
 LRV: 27.2%



*Limewashed Oak decors offer a large variety of patterns so colours may vary from one plank to the other within the same box.

iD Essential Click

iD Essential Click is the ideal solution for new build and renovation in domestic environments. It requires no or little subfloor preparation and can even be installed on some existing flooring. Its click system allows a floating installation, avoiding the use of glue, making the installation 20% quicker than with glue-down products*. Future renovations are also easier and cheaper as the product can be removed with no damage to the subfloor. With Tarkomfort Premium underlay, your iD Essential Click flooring will benefit from a 19dB acoustic sound reduction.

*Estimation - not binding

iD ESSENTIAL CLICK FINISHING TOUCH

- All references feature perfectly colour-matched skirtings for a perfect finish.
- Comes with a complete range of accessories for user safety and efficient installation and project completion.
- Easy and rapid installation is matched by a permanent hold for a long-lasting solution.

GREAT RESISTANCE AND EASY CLEANING

- Treated with the Tarkett TopClean™ surface protection that hardens the surface and simplifies cleaning and maintenance through reduced use of water, energy and chemical detergents.

SUSTAINABLE DESIGN

- Eco-effective products that minimise our impact on the environment, contribute to people's well-being and can be reused at end-of-life in other products.
- Contributes to improved indoor air quality with total VOC emissions at least 10 times lower than Europe's strictest standards.
- Uses a phthalate-free technology, based on alternative plasticizers that can be used for sensitive applications such as the production of toys, food packaging and medical devices.

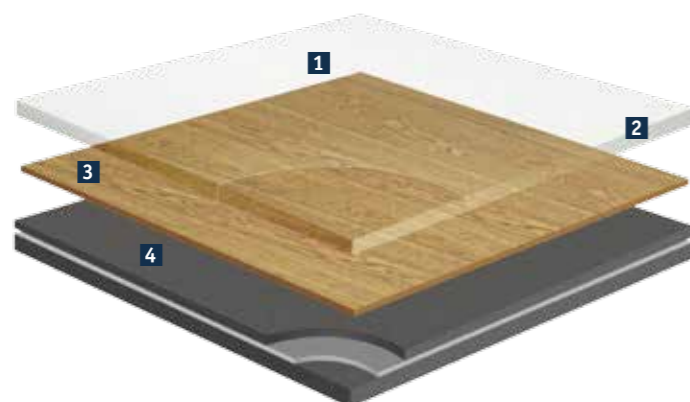

1. TopClean™ surface treatment
easy maintenance and higher resistance

2. Ultra tough transparent PVC wear layer

3. Design
printed PVC film

4. PVC Compact
backing and middle layers

Accessories

Skirting



Design & Colours	PVC decorative Skirting
LIMEWASHED OAK-BEIGE	26640 207
LIMEWASHED OAK-BROWN	26640 208
DELICATE OAK-NATURAL	26640 215
TOASTED OAK-LIGHT GREY	26640 210
TOASTED OAK-DARK GREY	26640 211
STONE-GREY	26640 224
RUST METAL-BROWN	26640 227
RUST METAL-BLACK	26640 226

PVC DECORATIVE SKIRTING

Compact skirting with decorative film and PUR surface treatment. Perfect matching with 8 iD Essential Click references, see skirting chart above (10 x 60 x 2020 mm). Ordering unit: 16 units of 2.02 lm.

Underlay

TARKOMFORT PRO

Acoustic Performance

- Acoustic high-resistance underlay specially designed for floating installation under LVT click (13dB with iD Essential Click)

Quick and easy to install

- Anti-slip film to be stripped off for easy installation
- Ref.: 24992 020 - Brown



TARKOFLAT LOOSE-LAY

Ready-to-use solution

- Reduces slight unevenness in older subfloors by up to 1.5mm depth and 3mm width
- Prevents telegraphic effect, the appearance of bumps and ridges from the substrate by up to 1.5mm depth
- Residential and light traffic commercial applications (Class 32 max.)

Quick and easy to install

Ref.: 3568 004 - Grey



Profile



FLEXIBLE PROFILE

Aluminium stop profile, to be screwed. Available in Silver (1456 011) and Stainless Steel (1456 012) finishes.

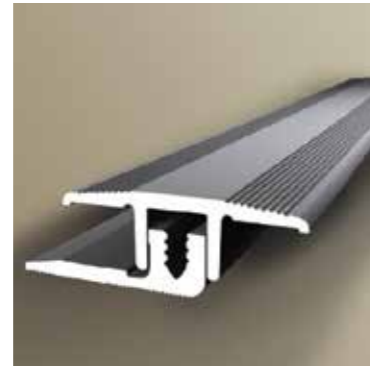

TRANSITION PROFILE

Aluminum transition profile, to be screwed. Available in Silver (1451 011) and Stainless Steel (1451 012) finishes.



RAMP PROFILE

Aluminium ramp profile, to be screwed. Available in Silver (1456 011) and Stainless Steel (1456 012) finishes.

Accessibility



WARNING TILE

Helps recognize a change in level, in accordance with regulatory requirements for disabled access and safety. Various formats available. Self-adhesive or to be glued to the floorcovering (according to product).

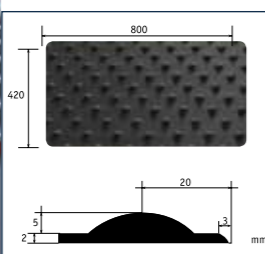

Self-adhesive rectangular tiles
Format: 815 x 420 x 8mm
Ordering unit: 1 box of 6 tiles

Self-adhesive square tiles
Format: 450 x 420 x 8mm
Ordering unit: 1 box of 20 tiles

	Self-adhesive	
	Rectangular tile	Square tile
White	1440 350	1440 450
Grey	1440 351	1440 451
Black	1440 352	1440 452
Ivory	1440 353	1440 453
Red	1440 354	1440 454
Yellow	1440 355	1440 455

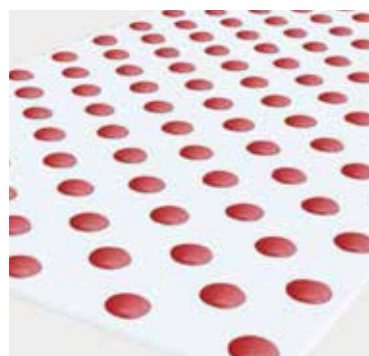

3D STUD

Ready-to-use podotactile studs to be simply fitted on top of the existing floorcovering.

Format (stud): 5 x 25mm
Ordering unit: 1 box of 200 studs

	Self-adhesive
White	1440 050
Grey	1440 051
Black	1440 052
Ivory	1440 053
Red	1440 054
Yellow	1440 055

Specification

Modular heterogeneous product. Product standard: EN ISO 10582.

CERTIFICATION & CLASSIFICATION	STANDARDS	iD Essential Click
Type of floor covering	EN ISO 10582	Compact Resilient Floorcovering
CE certification		Yes
Classification	EN ISO 10874	Residential: 23 Commercial: 31
TECHNICAL CHARACTERISTICS	STANDARDS	
Total thickness	EN ISO 24346	4.0 mm
Wear layer thickness	EN ISO 24340	0.30 mm
Surface treatment (PUR)		Yes - TopClean™
Bevelled edges		Yes - micro bevel
Total weight	EN ISO 23997	7400 g/m ²
Wear layer binder content	ISO 10582	Type I
Form of delivery	EN ISO 24342	
	Planks Box	18.3 x 122 cm 9 planks/box (= 2.009 m ²)
	Tiles	31 x 60.3 cm 9 tiles/box (= 1.682 m ²)
	ISO 24341 - EN 426 Sheet	-
TECHNICAL PERFORMANCES	STANDARDS	
Dimensional stability	EN ISO 23999	≤ 0.10 %
Reaction to fire	EN 13501-1	B _f -s1 over concrete and wood substrate
Residual indentation	EN ISO 24343-1	≤ 0.08 mm
Furniture leg	EN 424	No damage
Castor chair	ISO 4918	No damage
Underfloor heating		Suitable - max. 27°C
Thermal resistance	ISO 10456	0.03 m ² K/W
Impact sound reduction	EN ISO 717-2	ΔL _w = 5 dB 13 dB with Tarkomfort Pro
Reduction of in room impact noise	NF S31-074	78 dB (Class C - L _{n,e,w} < 85 dB)
Light fastness	EN ISO 105-B02	≥ 6
Resistance to chemicals	EN ISO 26987	High resistance
Slip resistance	EN 13893 DIN 51130	μ ≥ 0.30 DS R9 (tiles) R10 (planks)
Electrical properties	EN 1081	ca. 10 ⁹ Ohm
Colours		8

Technical data in force upon the date of publication (11/15). The values correspond to laboratory tests (no in situ test) and are subject to modification. Tarkett's instructions regarding installation, cleaning and maintenance shall be observed. Please contact your local sales rep. for these instructions.

Our Sustainability tag explains the content of our products and how they contribute to our sustainability strategy and human well-being.

CUSTOMS TARIFF: 48205000000F

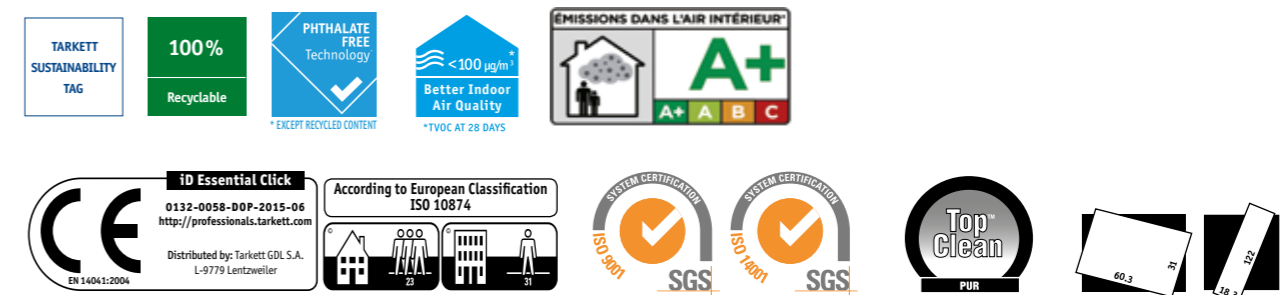

iD Inspiration **CLICK**

Take a look at the iD Inspiration Click range with its refined palette of expressive wood textures. The motifs on all 22 designs were exclusively created to match the natural essence of wood.





iD Inspiration CLICK

Think differently about colour and design to give a fresh look to your home interiors.



CLUB TIE

2 colours - Buy 3/4 of English oak - Beige and 1/4 of Vintage Teak - Grey*

Uses models:
English Oak - Beige (24)
Vintage Teak - Grey (92)

Plank format (cm): 18.5 x 121.2



FRENCH MARINIERE

2 colours - Buy 1/2 of each colour*

Uses models:
English Oak - Beige (24)
Vintage Teak - Grey (92)

Plank format (cm): 18.5 x 121.2



RANDOM CODE

3 colours - Buy 3/6 of English Oak - Beige, 2/6 of Vintage Teak - Grey and 1/6 of English Oak - Light*

Uses models:
English Oak - Beige (24)
English Oak - Light (26)
Vintage Teak - Grey (92)

Plank format (cm): 18.5 x 121.2

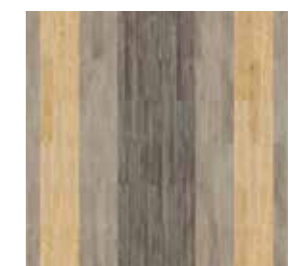

BOARDWALK

3 colours - Buy 1/3 of each colour*

Uses models:
English Oak - Beige (24)
English Oak - Light (26)
Vintage Teak - Grey (92)

Plank format (cm): 18.5 x 121.2



iD Inspiration CLICK

Think differently about colour and design to give a fresh look to your home interiors.



FRENCH MARINIER
2 colours - Buy 1/2 of each colour*
Uses models:
Modern Oak - Light (44)
Modern Oak - Grey (43)
Plank format (cm): 18.5 x 121.2



MAYAN RUG
3 colours - Buy 3/12 of Grey,
4/12 of Natural, 5/12 of Light*
Uses models:
Modern Oak - Light (44)
Modern Oak - Grey (43)
Modern Oak - Natural (45)
Plank format (cm): 18.5 x 121.2



ETHNIC BEAT
3 colours - Buy 1/10 of Grey,
3/10 of Natural and 6/10 of Light*
Uses models:
Modern Oak - Light (44)
Modern Oak - Grey (43)
Modern Oak - Natural (45)
Plank format (cm): 18.5 x 121.2



CROSSROAD
3 colours - Buy 1/10 of English Oak - Grey,
6/10 of Natural and 3/10 of Light*
Uses models:
Modern Oak - Light (44)
Modern Oak - Grey (43)
Modern Oak - Natural (45)
Plank format (cm): 18.5 x 121.2



ANTI K OAK - BEIGE
24804 001
LRV: 25.9% 18.5 x 121.2 cm



ANTI K OAK - NATURAL
24804 005
LRV: 20.5% 18.5 x 121.2 cm



ANTI K OAK - BROWN
24804 002
LRV: 18.2% 18.5 x 121.2 cm



ANTI K OAK - DARK GREY
24804 003
LRV: 25.3% 18.5 x 121.2 cm



BRUSHED PINE - GREY
24804 014
LRV: 26.7% 18.5 x 121.2 cm



BRUSHED PINE - BROWN
24804 013
LRV: 19% 18.5 x 121.2 cm



NATURAL WALNUT - YELLOW
24804 051
LRV: 31.5% 18.5 x 121.2 cm



NATURAL WALNUT - CLASSIC
24804 050
LRV: 17.4% 18.5 x 121.2 cm



ENGLISH OAK - LIGHT
24804 026
LRV: 25.6% 18.5 x 121.2 cm



ENGLISH OAK - NATURAL
24804 027
LRV: 24.9% 18.5 x 121.2 cm



ENGLISH OAK - BEIGE
24804 024
LRV: 28.8% 18.5 x 121.2 cm



ENGLISH OAK - BROWN
24804 025
LRV: 14.5% 18.5 x 121.2 cm



SOFT WALNUT - NATURAL
24804 076
LRV: 27.2% 18.5 x 121.2 cm



SOFT WALNUT - BROWN
24804 074
LRV: 12.5% 18.5 x 121.2 cm



VINTAGE TEAK - NATURAL
24804 093
LRV: 9.8% 18.5 x 121.2 cm



VINTAGE TEAK - GREY
24804 092
LRV: 15.9% 18.5 x 121.2 cm



MODERN OAK - LIGHT
24804 044
LRV: 35% 18.5 x 121.2 cm



MODERN OAK - NATURAL
24804 045
LRV: 35% 18.5 x 121.2 cm



MODERN OAK - GREY
24804 043
LRV: 19.7% 18.5 x 121.2 cm



OAK - NATURAL
24804 052
LRV: 29.5% 18.5 x 121.2 cm



WHITE OAK - LIGHT
24804 102
LRV: 42.7% 18.5 x 121.2 cm



WHITE OAK - GREY
24804 101
LRV: 28.4% 18.5 x 121.2 cm

iD Inspiration CLICK

iD Inspiration Click is an ideal solution for semi-commercial areas. Its durability and performance match the highest requirements of this market. It requires no or little subfloor preparation and can even be installed on some existing flooring. Its click system allows a floating installation, avoiding the use of glue, making the installation 20% quicker than with glue-down products and 10% quicker than with other click systems*. There is no drying period so your floor is immediately available.

*Estimation - not binding

FULL ACCESSORY PACKAGE

- Whether it's to ensure user safety, efficient installation or project completion, the iD Inspiration Click collection has everything to fulfill your expectations.
- Match your flooring design with the exact same colour of matching skirting to finish your project in style.
- Add the Tarkomfort Premium underlay to this product to obtain a 19 db acoustic sound reduction.

GREAT RESISTANCE AND EASY CLEANING

- Treated with a TopClean XP™ surface protection that hardens the surface and simplifies cleaning and maintenance through reduced use of water, energy and chemical detergents.

BETTER INDOOR AIR QUALITY & HYGIENE

- Contributes to improved indoor air quality with total VOC emissions at least 10 times lower than Europe's strictest standards.
- Uses a phthalate-free technology, based on alternative plasticizers that can be used for sensitive applications such as the production of toys, food packaging and medical devices.

SUSTAINABLE DESIGN

- Eco-effective product that minimise our impact on the environment.
- Contributes to people's well-being and that can be reused at end-of-life in other products.
- REACH compliant, 100% recyclable and is made in Germany in facilities certified ISO 9001 and ISO 14001.

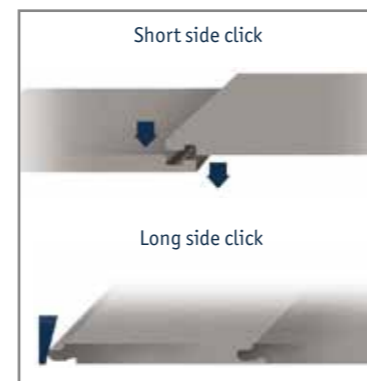

FOLD-DOWN CLICK SYSTEM

- The quickest and easiest system on the market.



- 1. TopClean XP™ PUR reinforcement**
extreme resistance and easy low cost maintenance
- 2. Surface embossing**
close to real materials
- 3. 0.55mm pure PVC transparent wear layer**
allowing class of use 33 and 42 ; hardwearing and indentation resistant
- 4. Design film**
22 design options in high definition printing
- 5. Core layer with glass fiber reinforcement**
exceptional dimensional stability and excellent resistance to tear and indentation
- 6. Stabilizing layer**
curl free product
- 7. Fold-down Click System**



Accessories

Skirting



1 PVC DECORATIVE SKIRTING

Compact skirting with decorative film and PUR surface treatment. Perfect matching with 22 iD Inspiration Click references, see skirting chart (10 x 60 x 2020 mm). Ordering unit: 16 units of 2.02 lm.

Design & Colours	Art.	1
ANTIK OAK-BEIGE	001	26640 001
ANTIK OAK-BROWN	002	26640 002
ANTIK OAK-DARK GREY	003	26640 003
ANTIK OAK-NATURAL	005	26640 005
BRUSHED PINE-BROWN	013	26640 013
BRUSHED PINE-GREY	014	26640 014
ENGLISH OAK-BEIGE	024	26640 024
ENGLISH OAK-BROWN	025	26640 025
ENGLISH OAK-LIGHT	026	26640 026
ENGLISH OAK-NATURAL	027	26640 027

Design & Colours	Art.	1
MODERN OAK-GREY	043	26640 043
MODERN OAK-LIGHT	044	26640 044
MODERN OAK-NATURAL	045	26640 045
NATURAL WALNUT-CLASSIC	050	26640 050
NATURAL WALNUT-YELLOW	051	26640 051
OAK-NATURAL	052	26640 052
SOFT WALNUT-BROWN	074	26640 074
SOFT WALNUT-NATURAL	076	26640 076
VINTAGE TEAK-GREY	092	26640 092
VINTAGE TEAK-NATURAL	093	26640 093
WHITE OAK-GREY	101	26640 101
WHITE OAK-LIGHT	102	26640 102

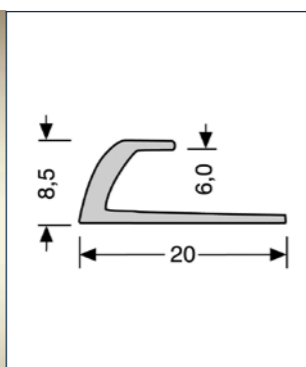

LVT SKIRTING CAP

Aluminium skirting cap for LVT to be combined with skirting bottom. To be glued.

- Perfect protection of the edge of the product
- Elegant finish

Size: 20 mm wide x 6 mm high inside x 8.5 mm high outside x 2500 mm long

Packaging: 10 units of 2,5lm in a cardboard box = 25 lm

Ref.: 26626 011: silver
26626 012: stainless steel

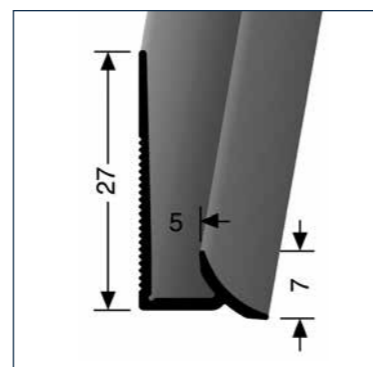

LVT SKIRTING BOTTOM

Aluminium skirting bottom for LVT, to be combined with skirting cap. To be glued.

- Real material to be inserted
- Also compatible for perfect finish in stairs

Size: 5 mm inside x 27 mm high x 7 mm lower lip x 2500 mm long

Packaging: 10 units of 2,5lm in a cardboard box = 25 lm

Ref.: 26626 021: silver
26626 022: stainless steel

Underlay

TARKOMFORT PRO

Acoustic Performance

- Acoustic high-resistance underlay specially designed for floating installation under LVT click (13dB with iD Inspiration Click)

Quick and easy to install

- Anti-slip film to be stripped off for easy installation

Ref.: 24992 020 - Brown



TARKOMFORT PREMIUM

Acoustic Performance

- Incorporates precision engineered material with sophisticated automotive and aeronautical technology

- Provides high-impact sound reduction of 19 dB with iD Inspiration Click

High resistance

- Gives stronger resistance to static indentation and rolling loads in heavy traffic areas with the use of high density material

Quick and easy to install

- Adheres firmly to the ground and prevent slipping with double-sided anti-slip texture with micro-suction cup effect
- Dispenses with post-installation wait, reduces downtime with loose-lay format and no adhesive
- Offers easy removal at end of life

Ref.: 24992 030 - Black



TARKOFLAT LOOSE-LAY

Ready-to-use solution

- Reduces slight unevenness in older subfloors by up to 1.5mm depth and 3mm width
- Prevents telegraphic effect, the appearance of bumps and ridges from the substrate by up to 1.5mm depth

- Residential and light traffic commercial applications (Class 32 max.)

Quick and easy to install

Ref.: 3568 004 - Grey



Profile



FLEXIBLE PROFILE

Aluminium stop profile, to be screwed. Available in Silver (1456 011) and Stainless Steel (1456 012) finishes.

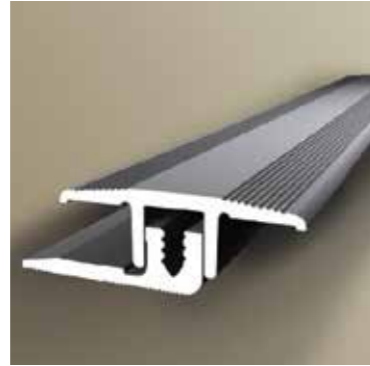

TRANSITION PROFILE

Aluminum transition profile, to be screwed. Available in Silver (1451 011) and Stainless Steel (1451 012) finishes.

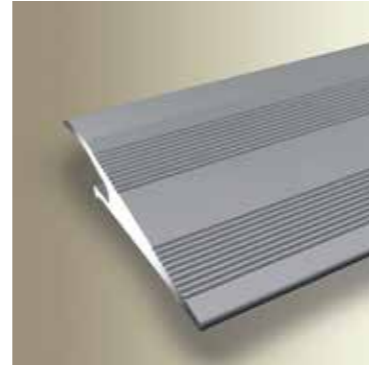

RAMP PROFILE

Aluminium ramp profile, to be screwed. Available in Silver (1456 011) and Stainless Steel (1456 012) finishes.

Accessibility



WARNING TILE

Helps recognize a change in level, in accordance with regulatory requirements for disabled access and safety. Various formats available. Self-adhesive or to be glued to the floorcovering (according to product).

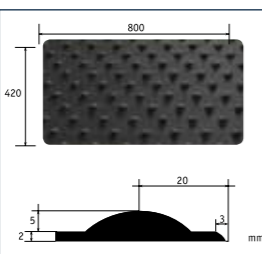

Self-adhesive rectangular tiles
Format: 815 x 420 x 8mm
Ordering unit: 1 box of 6 tiles

Self-adhesive square tiles
Format: 450 x 420 x 8mm
Ordering unit: 1 box of 20 tiles

	Self-adhesive	
	Rectangular tile	Square tile
White	1440 350	1440 450
Grey	1440 351	1440 451
Black	1440 352	1440 452
Ivory	1440 353	1440 453
Red	1440 354	1440 454
Yellow	1440 355	1440 455

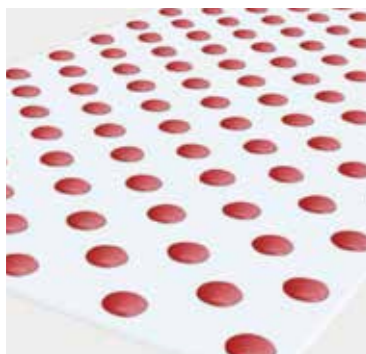

3D STUD

Ready-to-use podotactile studs to be simply fitted on top of the existing floorcovering.

Format (stud): 5 x 25mm
Ordering unit: 1 box of 200 studs

	Self-adhesive
White	1440 050
Grey	1440 051
Black	1440 052
Ivory	1440 053
Red	1440 054
Yellow	1440 055

Specification

Modular vinyl floorcovering, with glass fibre reinforcement. TopClean XP™ polyurethane reinforcement. In plank form. Product standard: EN ISO 10582.

CERTIFICATION & CLASSIFICATION	STANDARDS	iD Inspiration Click
Type of floor covering	EN ISO 10582	Compact Resilient Floorcovering
CE certification		Yes
Classification	EN ISO 10874	Commercial: 33 Industrial: 42
TECHNICAL CHARACTERISTICS	STANDARDS	
Total thickness	EN ISO 24346	5.0 mm
Wear layer thickness	EN ISO 24340	0.55 mm
Surface treatment (PUR)		Yes - TopClean XP™
Bevelled edges		No
Total weight	EN ISO 23997	8.300 g/m ²
Wear layer binder content	ISO 10582	Type I
Form of delivery	EN ISO 24342 Planks	18.5 x 121.2 cm 8 planks/box (= 1.793 m ² - 15.25 kg) 64 boxes/pallet (= 114.752 m ² - 991 kg)
	ISO 24341 - EN 426 Sheet	-
TECHNICAL PERFORMANCES	STANDARDS	
Dimensional stability	EN ISO 23999	≤ 0.10 %
Reaction to fire	EN 13501-1	B _{f1} s1 over concrete and wood substrate
Residual indentation	EN ISO 24343-1	≤ 0.10 mm
Furniture leg	EN 424	No damage
Castor chair	ISO 4918	No damage
Curl resultant to heat	ISO 23999	≤ 2 mm
Underfloor heating		Suitable - max. 27°C
Thermal resistance	ISO 10456	0.03 m ² K/W
Impact sound reduction	EN 717-2	ΔL _w = 3 dB 19 dB with Tarkomfort Premium
Reduction of in room impact noise	NF S31-074	Class C - L _{w,eq} < 85 dB
Light fastness	EN ISO 105-B02	≥ 6
Resistance to chemicals	EN ISO 26987	High resistance
Slip resistance	EN 13893 DIN 51130	μ ≥ 0.30 R9
Colours		22

Technical data in force upon the date of publication (11/15). The values correspond to laboratory tests (no in situ test) and are subject to modification. Tarkett's instructions regarding installation, cleaning and maintenance shall be observed. Please contact your local sales rep. for these instructions.

CUSTOMS TARIFF: 482050000000F

Our Sustainability tag explains the content of our products and how they contribute to our sustainability strategy and human well-being.

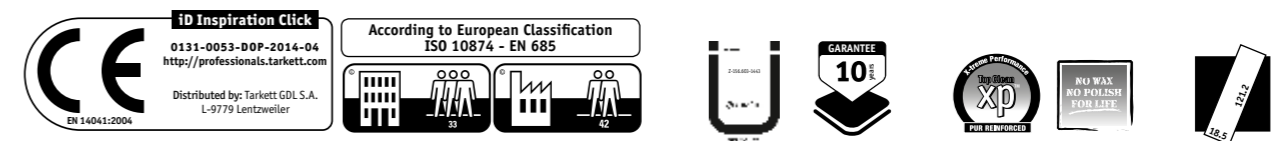

FLOOR IS THE NEW PLAYGROUND

flooristhewnewplayground.tarkett.com

■ **WESTERN EUROPE:** Austria: Tarkett Holding GmbH, Niederlassung Wien – Tel. +43 1 47 88 062 ■ Belgium: Tarkett France Belux – Tel. +32 16 35 98 80 ■ Denmark: Tarkett A/S – Tel. +45 43 90 60 11 ■ Finland: Tarkett Oy – Tel. +358 9 4257 9000 ■ France: Tarkett SAS – Tel. +33 1 41 20 42 49 ■ Germany: Tarkett Holding GmbH, Bereich Objekt – Tel. +49 62 33 810 ■ Greece: Tarkett Monoprosopi Ltd – Tel. +30 210 6745 340 ■ Italy: Tarkett S.p.A. – Tel. +39 0744 7551 ■ Luxembourg: Tarkett GDL SA – Tel. +352 949 211 8804 ■ Netherlands: Tarkett Holding GmbH, Vestiging Nederland – Tel. +31 76 57 80 760 ■ Norway: Tarkett AS – Tel. +47 32 20 92 00 ■ Portugal: Tarkett SA – Tel. +351 21 427 64 20 ■ Spain: Tarkett Floors S.L. – Tel. +34 91 358 00 35 ■ Sweden: Tarkett Sverige AB – Tel. +46 771 25 19 00 ■ Switzerland: Tarkett Holding GmbH, Bereich Objekt Schweiz – Tel. +41 043 233 79 24 ■ Turkey: Tarkett Aspen – Tel. +90 212 213 65 80 ■ United Kingdom: Tarkett Ltd – Tel. +44 (0) 1622 854 040 ■ **EASTERN EUROPE:** Baltic Countries: Tarkett Baltics: Tel. +370 37 262 220 ■ Czech Republic: Tarkett France SAS, org. slozka – Tel. +420-271 001 602 ■ Hungary: Tarkett France SAS – Tel. +36 1 437 8150 ■ Poland: Tarkett Polska Sp. z o.o. – Tel. +48 22 639 31 68 ■ Russian Federation: ZAO Tarkett RUS – Tel. +7 495 775 3737 ■ Slovakia: Tarkett France SAS, org.zlozka – Tel. +421 248 291 317 ■ South East Europe: Tarkett Trade d.o.o. – Tel. +381 21 7557 649 (44) 569 12 21 ■ Ukraine: Tarkett UA – Tel. +38 (0) 44 569 12 21 ■ **ASIA AND OCEANIA:** Australia: Tarkett Australia Pty Ltd – Tel. +61 2 88 53 12 00 ■ China: Tarkett Floor Covering (Shanghai) Co. Ltd. – Tel. +86 (21) 60 95 68 38 ext.841 ■ Hong Kong: Tarkett Asia Pacific Ltd. – Tel. +852 2511 8716 ■ India: Tarkett France (India Branch) – Tel. +91 11 4352 4073 ■ South East Asia: Tarkett Flooring Singapore Pte Ltd – Tel. +65 6346 1585 ■ **AFRICA:** Tarkett International: Tel. +33 1 41 20 41 01 ■ **MIDDLE EAST:** Tarkett Middle East: Tel. +961 1 51 3363/4 ■ Israel: Tarkett International: Tel. +33 1 41 20 41 01 ■ **NORTH AMERICA:** USA: Tarkett Inc. – Tel. +1 713 869 5811 / Johnsonite – Tel. +1 440 543 8916 ■ Canada: Tarkett Inc. – Tel. +1 450 293 173 ■ **LATIN AMERICA:** Brazil: Tarkett Fademac – Tel. 55 12 3954 7108 ■ Other countries: Tarkett America Latina – Tel. +55 11 3047 7200 ■ Argentina - Chile - Uruguay: Tarkett Latam Mercosur - Tel. 54 11 48 06 74 28 / 54 9 11 44 46 88 82 ■ Colombia - Panama - Caribbean: Tarkett Latam Andina - Tel. 57 1 759 5781 / 57 312 273 1566 ■ Bolivia - Ecuador - Paraguay - Peru: Tarkett Latam Sur Oeste - Tel. 55 11 3047 7233 ■ Mexico / Central America: Tarkett Latam Mexico - Tel. 52 735 35 63 918 / 52 55 51 07 9524



THE ULTIMATE
FLOORING EXPERIENCE